



# PSE

## Refrigeration Dryer (575V/3/60Hz)

EN User Manual  
ES Manual de uso  
FR Manuel d'utilisation

**PSE1400**  
**PSE1600**  
**PSE2000**  
**PSE2400**  
**PSE3000**  
**PSE3800**  
**PSE5000**  
**PSE6000**

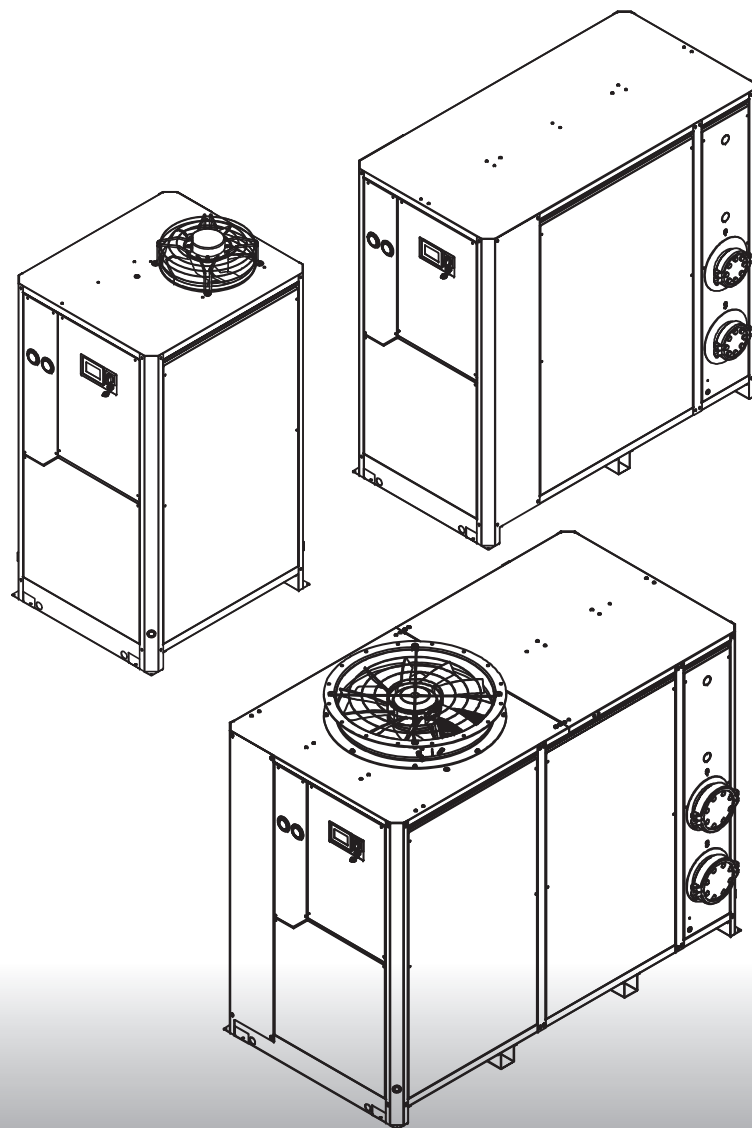



## Index

<b>1 Safety</b>	<b>1</b>
1.1 Importance of the manual.....	1
1.2 Warning signals.....	1
1.3 Safety instructions.....	1
1.4 Residual risks.....	2
<b>2 Introduction</b>	<b>2</b>
2.1 Transportation.....	2
2.2 Handling.....	2
2.3 Inspection.....	2
2.4 Storage.....	2
<b>3 Installation</b>	<b>3</b>
3.1 Procedures.....	3
3.2 Operating space.....	3
3.3 Condenser version.....	3
3.4 Tips.....	3
3.5 Electrical connection.....	3
3.6 Condensate drain connection.....	3
<b>4 Commissioning</b>	<b>4</b>
4.1 Preliminary checks.....	4
4.2 Starting.....	4
4.3 Operation.....	4
4.4 Stop.....	4
<b>5 Control</b>	<b>5</b>
5.1 Control panel.....	5
5.2 Main menu.....	5
5.2.1 Machine status (I/O).....	5
5.2.2 Pressure.....	6
5.2.3 Temperature.....	6
5.2.4 General.....	7
5.2.4.1 Language selection.....	7
5.2.4.2 Set Date/Time.....	7
5.2.4.3 User menu.....	7
5.2.4.4 Parameters.....	8
5.2.5 Serial number date.....	9
5.2.6 Download.....	9
5.3 Alarms/warnings.....	10
5.3.1 List of alarms/warnings.....	10
5.4 Rapid menu.....	11
<b>6 Maintenance</b>	<b>12</b>
6.1 General instructions.....	12
6.2 Refrigerant.....	12
6.3 Preventive Maintenance Programme.....	12
6.4 Dismantling.....	13
<b>7 Troubleshooting</b>	<b>14</b>
<b>8 Appendix</b>	

## 1 Safety

### 1.1 Importance of the manual

- Keep it for the entire life of the machine.
- Read it before any operation.
- It is subject to changes: for updated information see the version on the unit.

### 1.2 Warning signals



Instruction for avoiding danger to persons.



Instruction for avoiding damage to the equipment.





The presence of a skilled or authorized technician is required.





There are symbols whose meaning is given in the para. 8.1

### 1.3 Safety instructions

 Every unit is equipped with an electric disconnecting switch for operating in safe conditions. Always use this device in order to eliminate risks maintenance.

 The manual is intended for the end-user, only for operations performable with closed panels: operations requiring opening with tools must be carried out by skilled and qualified personnel.

 Do not exceed the design limits given on the data plate.

  It is the user's responsibility to avoid loads different from the internal static pressure. The unit must be appropriately protected whenever risks of seismic phenomena exist.

 The safety devices on the compressed air circuit must be provided for by the user

 The dimensioning of the safety devices of the air compressed circuit must be according to the specifications of the system and legislation in force locally.

Only use the unit for professional work and for its intended purpose.

The user is responsible for analyzing the application aspects for product installation, and following all the applicable industrial and safety standards and regulations contained in the product instruction manual or other documentation supplied with the unit.

Tampering or replacement of any parts by unauthorized personnel and/or improper machine use exonerate the manufacturer from all responsibility and invalidate the warranty.

The manufacturer declines present or future liability for damage to persons, things and the machine, due to negligence of the operators, non-compliance with all the instructions given in this manual, and non-application of current regulations regarding safety of the system.

The manufacturer declines any liability for damage due to alterations and/or changes to the packing.

It is the responsibility of the user to ensure that the specifications provided for the selection of the unit

or components and/or options are fully comprehensive for the correct or foreseeable use of the machine itself or its components.

 **IMPORTANT:** The manufacturer reserves the right to modify this manual at any time. The most comprehensive and updated information, the user is advised to consult the manufacturer.

## 1.4 Residual risks

The installation, start up, stopping and maintenance of the machine must be performed in accordance with the information and instructions given in the supplied technical documentation and always in such a way to avoid the creation of a hazardous situation. The risks that it has not been possible to eliminate in the design stage are listed in the following table:

Part affected	Residual risk	Manner of exposure	Precautions
heat exchanger coil	small cuts	contact	avoid contact, wear protective gloves
fan grill and fan	lesions	insertion of pointed objects through the grill while the fan is in operation	do not poke objects of any type through the fan grille or place any objects on the grill
inside the unit: compressor and discharge pipe	burns	contact	avoid contact, wear protective gloves
inside the unit: metal parts and electrical wires	intoxication, electrical shock, serious burns	defects in the insulation of the power supply lines upstream of the electrical panel; live metal parts	adequate electrical protection of the power supply line; ensure metal parts are properly connected to earth
outside the unit: area surrounding the unit	intoxication, serious burns	fire due to short circuit or overheating of the supply line upstream of the unit's electrical panel	ensure conductor cross-sectional areas and the supply line protection system conform to applicable regulations

## 2 Introduction

This manual is in reference to refrigeration dryers designed to remove water vapor from compressed air.

### 2.1 Transportation

The packed unit must:

- remain upright;
- be protected against atmospheric agents;
- be protected against impacts.

### 2.2 Handling

Use a fork-lift truck suitable for the weight to be lifted, avoiding any type of impact.

### 2.3 Inspection

- All the units are assembled, wired, charged with refrigerant and oil and tested under standard operating conditions in the factory;
- on receiving the machine check its condition: immediately notify the transport company in case of any damage;
- unpack the unit as close as possible to the place of installation.

### 2.4 Storage

If several units have to be stacked, follow the notes given on the packing. Keep the unit packed in a clean place protected from damp and bad weather.

## 3 Installation

☞ Install indoors in a clean, dry area that is protected from the elements, direct sunlight and/or other harsh conditions.

⚠ The product installed must be suitably protected against fire risk (Ref. EN378-3).

### 3.1 Procedures

Install the dryer inside, in a clean area protected from direct atmospheric agents (including sunlight).

⚠ Make sure to screw down the stud bolts in the flanges before connecting the counterflanges (see par. 8.6 appendix).

☞ Comply with the instructions given in par. 8.2 and 8.3).

All dryers must be fitted with adequate pre-filtration near the dryer air inlet. Seller is excluded any obligation of compensation or refund for any direct or indirect damage caused by its absence

☞ Pre-filter element (for 3 micron filtration or better) must be replaced at least once a year, or sooner as per manufacturer recommendations.

☞ Correctly connect the dryer to the compressed air inlet/outlet connections.

### 3.2 Operating space

Leave a space of 1.5 m around the unit.

Leave a space of 2 m above dryer models with vertical condensation air expulsion.

### 3.3 Condenser version

#### Air-cooled version (Ac)

Do not create cooling air recirculation situations. Do not obstruct the ventilation grilles.

#### Water-cooled version (Wc)

If not provided in the supply, fit a mesh filter on the condensation water inlet.

☞  Inlet condensation water characteristics:

Temperature	≥50°F (10°C)	CL <sup>-</sup>	<50 ppm
ΔT IN/OUT	5-15°C	CaCO <sub>3</sub>	70-150 ppm
Max % glycol	50	O <sub>2</sub>	<0.1 ppm
Pressure	(3-10 barg)	Fe	<0.2 ppm
PH	7.5-9	NO <sub>3</sub>	<2 ppm
Electrical conductivity	10-500 μS/cm	HCO <sub>3</sub> <sup>-</sup>	70-300 ppm
Langelier saturation index	0-1	H <sub>2</sub> S	<0.05 ppm
SO <sub>4</sub> <sup>2-</sup>	<50 ppm	CO <sub>2</sub>	<5 ppm
NH <sub>3</sub>	<1 ppm	Al	<0.2 ppm

Please note that for special cooling water types such as demineralized, deionized or distilled it is necessary to contact the manufacturer to verify which kind of condenser should be used since the standard material may not be suitable.

### 3.4 Tips

To prevent damage to the internal parts of the dryer and air compressor, avoid installations where the surrounding air contains solid and/or gaseous pollutants (e.g. sulphur, ammonia, chlorine and installations in marine environments).

The ducting of extracted air is to be avoided for versions with axial fans

### 3.5 Electrical connection

Use approved cable in conformity with the local laws and regulations (for minimum cable section, see par. 8.3

Install a differential thermal magnetic circuit breaker with contact opening distance 3 mm ahead of the system (RCCB - IDn = 0.3A) (see the relevant current local regulations).

The nominal current In of the magnetic circuit breaker must be equal to the FLA with an intervention curve type D.

Select the power supply and insert a bridge as shown below:

**S7-S6 for 400/3/50**

**S8-S6 for 460/3/60**

Inside the electrical panel there is an instruction label.

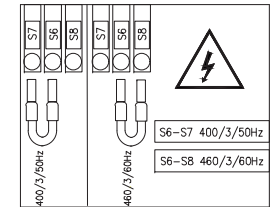

### 3.6 Condensate drain connection

☞ Make the connection to the draining system, avoiding connection in a closed circuit shared by other pressurized discharge lines. Check the correct flow of condensate discharges. Dispose of all the condensate in conformity with current local environmental regulations.

## 4 Commissioning

### 4.1 Preliminary checks

Before commissioning the dryer, make sure:

- installation was carried out according that given in the section 3;
- the air inlet valves are closed and that there is no air flow through the dryer;
- the power supply is correct;
- with Wc version, open the cooling water circuit a few minutes before starting the dryer.

### 4.2 Starting

1. switch the power on by turning the "MAIN SWITCH "



" to "I ON": appear this information:

**THE CRANKCASE HEATER MUST BE SWITCHED ON 12 HOURS BEFORE STARTING THE DRYER.**

After, touch to enter on the control panel.



2. Touch to strat, the button changes the color from grey to green, to signal that the dryer is

now in operation .

3. Start the dryer before the air compressor;

Failure to comply with this rule may cause serious damage to the compressor.

Fan (Ac version): if connected with the wrong phase sequence they turn in the opposite direction, with the risk of being damaged (in this case the air exits the dryer cabinet from the condenser grilles instead from the fan grille - see par. 8.6/8.7 (appendix) for correct air flow); immediately invert two phases.

4. Wait 5 minutes, then slowly open the air inlet valve;

5. slowly open the air outlet valve: the dryer is now drying.

#### Phases Monitor

If appears to display the alarm "phase monitor ", during the start up of the dryer, the user must verify the wiring of the input terminals of the disconnecting switch of the dryer.

### 4.3 Operation

- Leave the dryer on during the entire period the air compressor is working;
- The dryer operates in automatic mode, therefore field settings are not required;
- In the event of unforeseen excess air flows, by-pass to avoid overloading the dryer.
- Avoid inlet air temperature fluctuations.

### 4.4 Stop

1. Stop the dryer 2 minutes after the air compressor stops or in any case after interruption of the air flow;
2. make sure compressed air does not enter the dryer when the dryer is disconnected or if an alarm occurs.



3. Press to switch off the dryer. The button changes the color in grey



4. Turn the MAIN SWITCH " " to "O OFF" to switch the power off.



Wc version, close the water circuit with the dryer stopped.

	EN - THE CRANKCASE HEATER MUST BE SWITCHED ON 12 HOURS BEFORE STARTING THE DRYER.
	IT - LA RESISTENZA CARTER DEVE ESSERE INSERITA 12 ORE PRIMA DI AVVIARE L'ESSICCATORE.
	FR - LA RESISTANCE CARTER DOIT ETRE BRANCHEE 12 HEURES AVANT LA MISE EN MARCHÉ DU SECHÉUR.
	DE - DIE VERSORGUNG DER KURBELWANNENHEIZUNG IST 12 STUNDEN VOR DER EINSCHALTUNG DES TROCKNERS FREIZUGEBEN.

## 5 Control

### 5.1 Control panel

Touch buttons	Function
	Dryer OFF (Black)
	Dryer ON (Green)

LOCAL = Local configuration  
REMOTE = Remote configuration

Function	Touch buttons	Function
 Fan operation rate(only for air condenser version)		Access to information menu: machine status, pressures, temperatures, general settings, consumption, user password
 Hot gas valve operation rate		Gray = no alarm Red = warning Flashing Red = Alarm
 Energy saving %(cycling)		Dryer OFF = grey light Cycling active = flashing green Compressor active = light blue
		grey = Condensate drain OFF green = Condensate drain ON

Function	Touch buttons	Function
 Dew point trend	 MANUAL DRAIN	Touch: for a manual drain

### 5.2 Main menu

Touch to enter on "Information" menu.

When one of the "touch buttons" is touched, for a few seconds the outline lights up to confirm that the selection has been made.

This is for each "touch button" present on the control panel.

Touch to return to control panel.

#### 5.2.1 Machine status (I/O)

Touch to enter on "machine status" menu. This is the list of inputs: A led, close the description, indicates if the protections / functions / configurations is: active = green light no active = grey light. e.g .

Touch to enter on the next page.

**Status of Input**

- High pressure switch
- Low pressure switch
- Thermal protection compressor
- Thermal protection fan
- Phases sequence control
- Dryer remote control
- Condensate level 1
- Condensate level 2
- Condensate level 3

This is the list of outputs:

**Status of Output**

- Plant status ON
- General Alarm
- Compressor ON
- Fan ON
- Liquid solenoid valve
- Condensate drain 1
- Condensate drain 2
- Condensate drain 3



Touch to return to the previous menu.

## 5.2.2 Pressure

Touch  to enter on "pressure" menu to visualize: condensing pressure, fan operating rate, evaporating pressure, hot gas valve operating rate.



Touch a specific parameter to view its data trend of performance over time. e.g.

"Condensing/Evaporating pressure"

use  and  to scroll on the graph.

Touch  to the previous menu.

"Hot gas valve/fan operating rate"

use  and  to scroll on the graph.

Touch  to the previous menu.

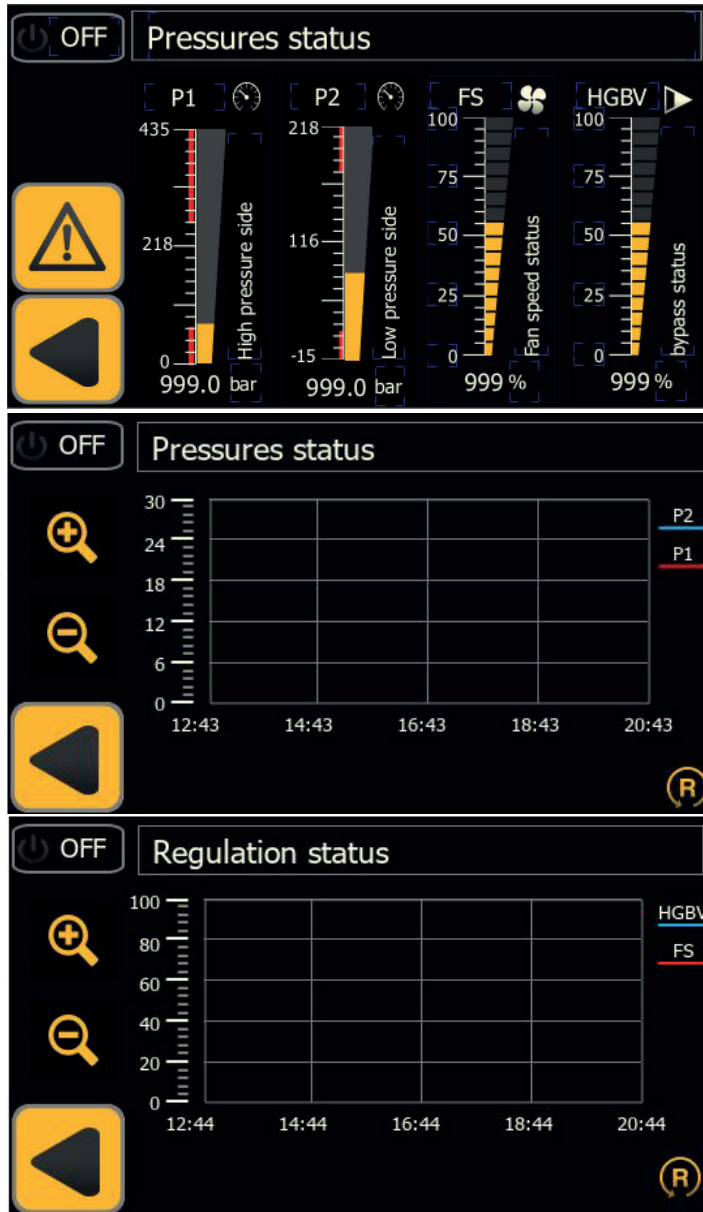

## 5.2.3 Temperature

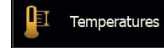
Touch  to visualize temperature readings by the temperature probes of the circuit diagram.



touch  to enter on the next page.

B4 = active only for multicooler version

Touch one of the low pressure temperatures values to see a data trend of all the probes in the low pressure circuit.



Touch one of the high pressure temperature values to see a data trend of all the probes in the high pressure circuit

Temperature - Low pressure side

use  and  to scroll on the graph.

Touch  to the previous menu.

Temperature - High pressure side

use  and  to scroll on the graph.

Touch  to the previous menu.

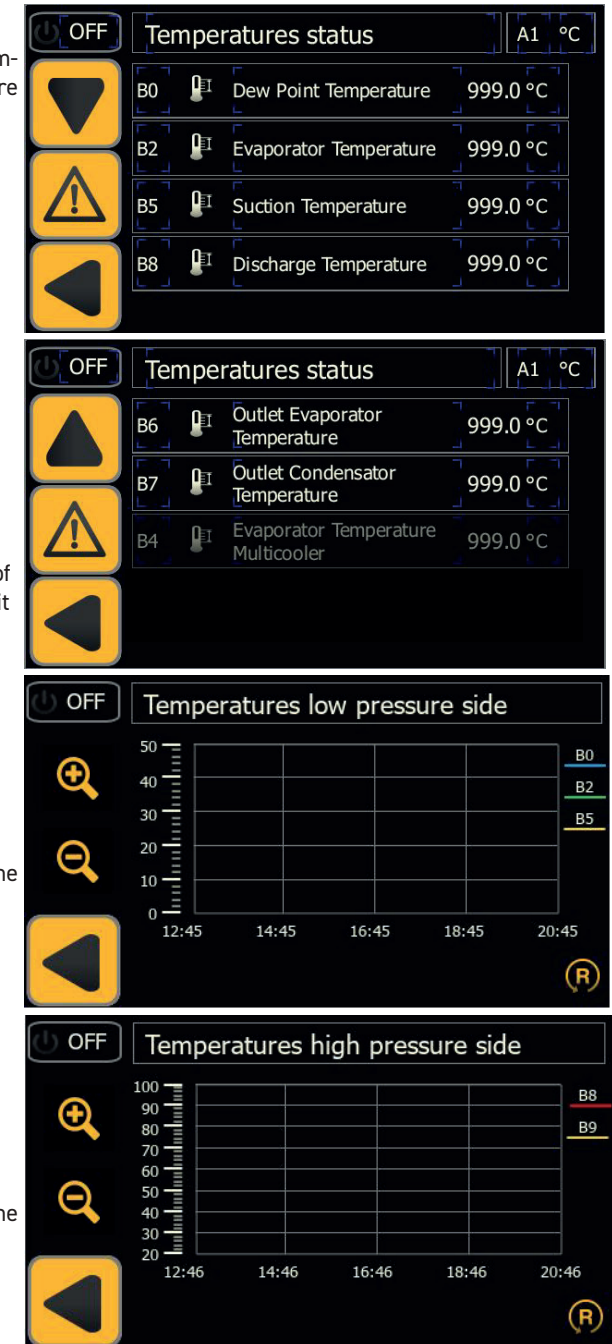

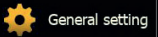

## 5.2.4 General

Touch  to enter on "general" menu with the following section: language; date/hour; parameter ; maintenance; cycling/continuous operating.

Touch any menu to view/adjust.

Touch  to return to the control panel.

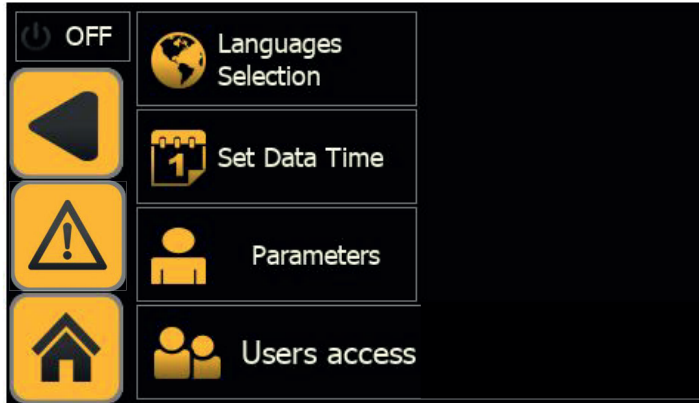

### 5.2.4.1 Language selection

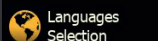
Touch  to enter on language menu. Touch the language you need. Automatically you return to the main menu with the chosen language.

Touch  to the previous menu.

Touch the language you need. Automatically you return to the main menu with the chosen language.

Touch  to the previous menu.

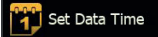

## 5.2.4.2 Set Date/Time

Touch  to enter on "date/Hour" menu. Set time and date to proceed with the change.

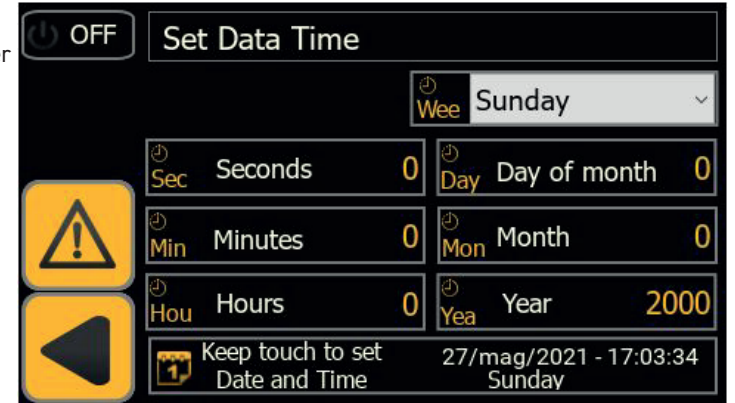

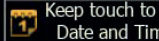
Press for 2 seconds  to confirm.

Touch  to return to the previous menu.

### 5.2.4.3 User menu

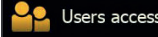
Touch  to enter on "User" menu. This menu is reserved for Parker service technician.

User name:

Password:

Show password

### 5.2.4.4 Parameters

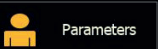
Touch  to enter on "parameter" menu with the following sections: probes, condensate drain, configuration, maintenance, cycle.

Touch the "button touch" to enter on menu.

Touch  to return to the previous menu.

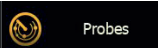

### Probes

Touch  to set the warnings and delays or the minimum/maximum of dew point.

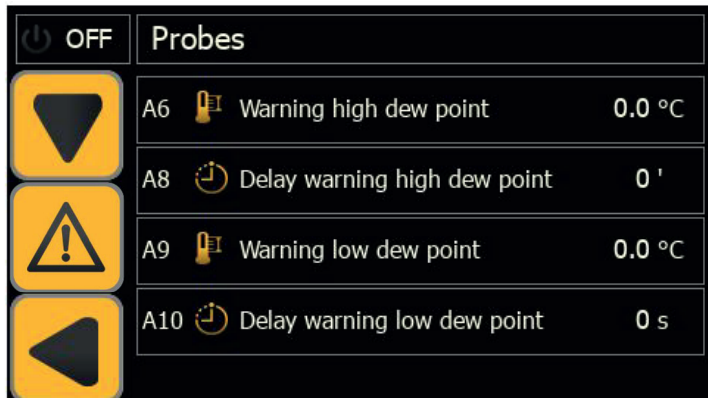

### Condensate drain

Touch  to enter on the menu "condensate drain" to choose:

1. timed drain (choosing the closing and opening times);
2. capacitive drain;
3. continuous drain (external drain).

Touch  to the previous menu.

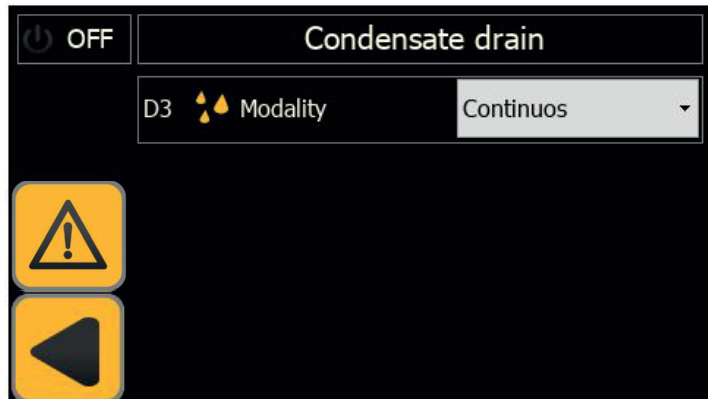

### Configuration

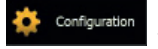
Touch  to enter on configuration display with the following menu:

1. Unit of measure C° / F°;
2. Enabling remote control;
3. Enabling only alarms or alarms / warnings;
4. Reset the settings with the default parameters.

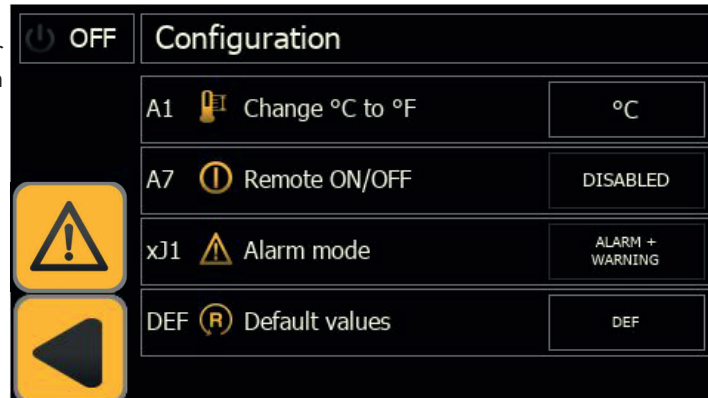



use the "button touch" close to the description to make your choice.

 To manage REMOTE OFF mode, remove the bridge between terminals: 87-92, and connect the remote start/stop switch (to be provided for by the customer).

### Maintenance

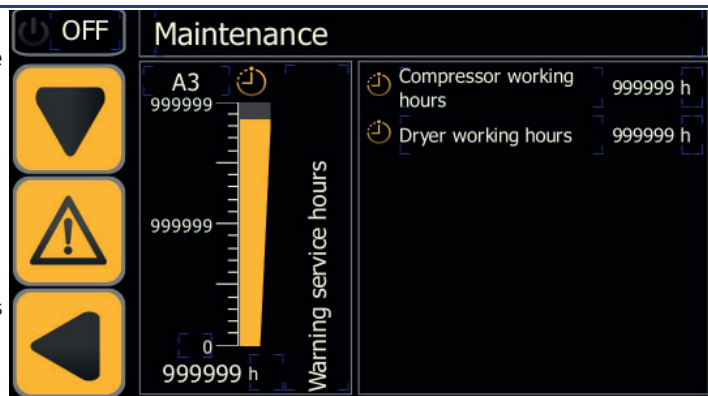
Touch  to see the work hours compressor/dryer.



Touch  to the previous menu.

## Operating

Touch  to choose the type of operating : continuous; cycling (energy saving).

Touch the parameter to make adjustment

Touch  to the previous menu.

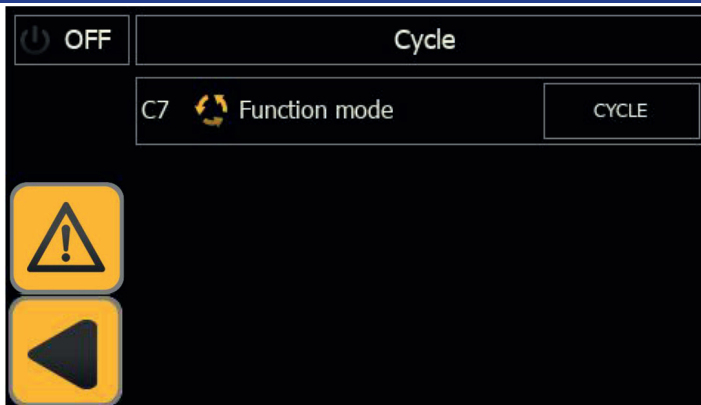

## Modbus

Touch  to set Modbus parameters. MODBUS RTU (RS485)

touch  to enter on the next page.

MODBUS TCP/IP

Touch  to the previous menu.

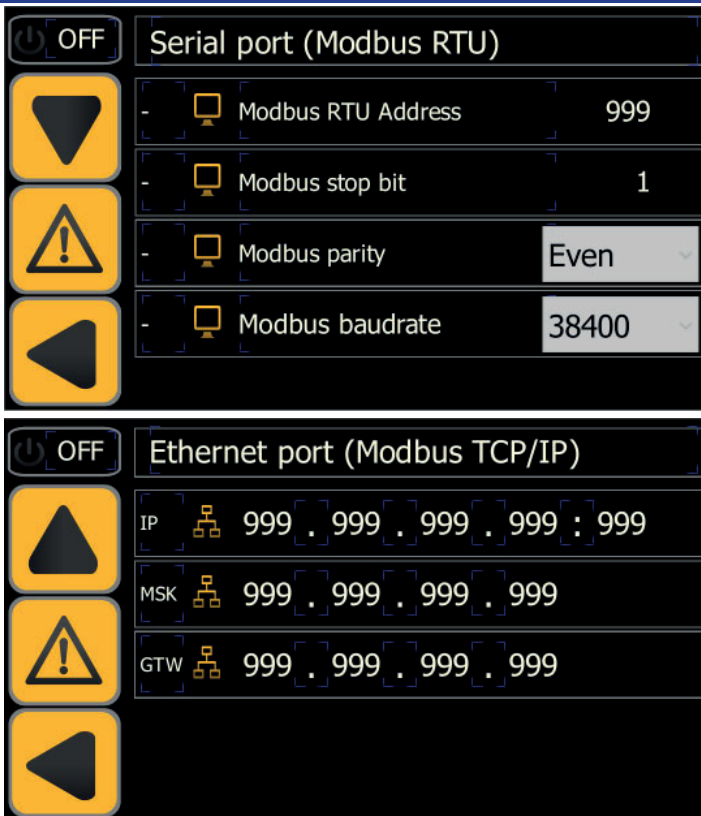

Switch OFF/Switch ON the dryer to confirm the configuration.

## Cloud

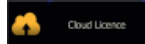
Touch  to see "password" to cloud.

This option is on going.

Touch  to the previous menu.

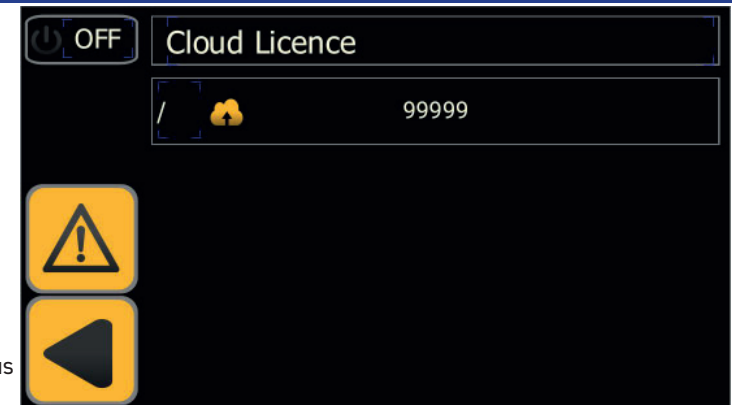

### 5.2.5 Serial number date

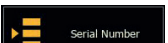
Touch  to enter on "serial number date" window.

Touch  to return to control panel.

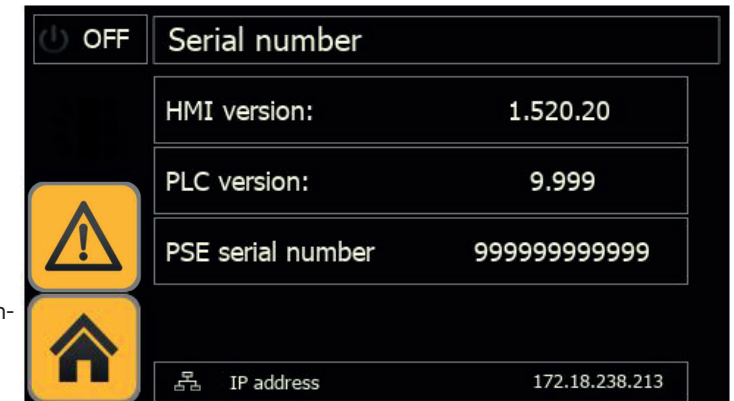

### 5.2.6 Download

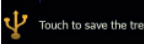
Insert the USB and touch  to proceed with the download of the graphics of the temperatures and pressures. Use a USB with led, that show you the downloading phase.

Touch  to the previous menu.

## 5.3 Alarms/warnings

Touch  to enter on "alarms/warning" or "alarm" menu:

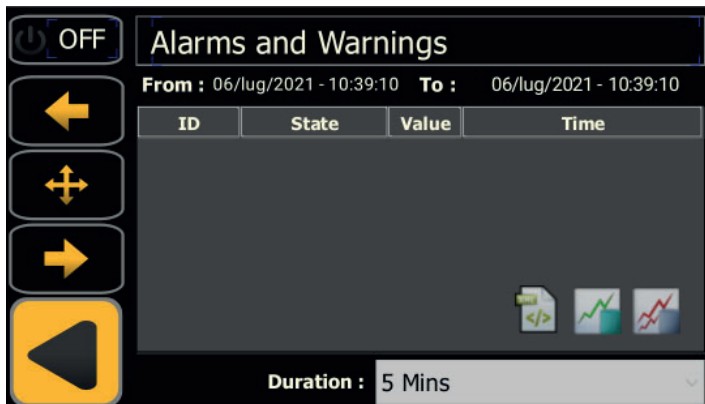

Touch "duration" to change the time of reserch.

When the nominal working conditions have been restored, some warning and alarm are automatically reset, for other alarms/warning it is necessary to perform a manual reset.

Touch  to reset the alarms.

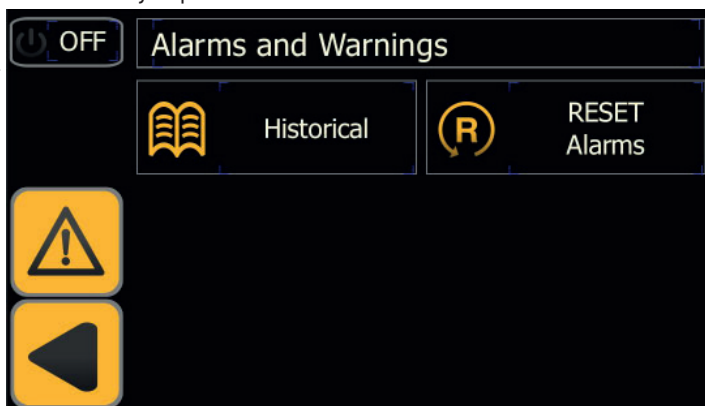

Touch  to visualize the historical alarms with:

the alarm code, the date, the number of alarms, the position in the sequence of occurrence, and the alarm activation time.

Touch  to the previous menu.

### 5.3.1 List of alarms/warnings

a = alarm; w = warning.

Code	Alarm/Warning	Cause
aLD	low dew point alarm	temperature B0<A9 for more than A10 seconds.
aLT	low evaporator temperature alarm	temperature B2<A12 for more than A13 seconds
aHT2	high discharge temperature alarm	temperaure B8>A11
aHP	high pressure alarm	high pressure switch is tripped
aLP	low pressure alarm	low pressure switch is tripped
aLTA	low multicooter temperature alarm	temperature B4<A12 for more than A13 seconds
aPI*	Compressor thermal protection alarm	Compressor thermal protection is tripped
aPH	phase monitoring alarm	phase monitoring relay is tripped (only for 460-750)
aCM1	communication expansion 1 alarm	the expansion 1 is not communicating
aCM2	communication expansion 2 alarm	the expansion 2 is not communicating
wB0	warning probe B0	probe broken or not connected
wB2	warning probe B2	probe broken or not connected
wB4	warning probe B4	probe broken or not connected
wB5	warning probe B5	probe broken or not connected
wB6	warning probe B6	probe broken or not connected
wB8	warning probe B8	probe broken or not connected
aFP1	high pressure transmitter P1 alarm	transmitter broken or not connected
wHD	high dew point warning	temperature B0>A6 for more than A8 minutes
wHT1	high discharge temperature warning	temperature B8>A14 for more than A15 minutes
wHP1	high pressure warning	pressure P1>A16 for more than 2 seconds
wHB5	high suction temperature warning	temperture B5>A18 for more than 1 minute
wLP2	low pressure warning	pressure P2<A21 for more than 150 seconds
wSR	Scheduled maintenance warning	the service time is elapsed
wDR1	drain 1 warning	the condensate is not discharge from cooler 1
wDR2	drain 2 warning	the condensate is not discharge from cooler 2
wDR3	drain 3 warning	the condensate is not discharge from cooler 3
aFP2	low pressure transmitter P2 alarm	transmitter broken or not connected

\* for models from 900-1800 the alarm could also have the meaning of inverted phases.

## 5.4 Rapid menu

Reach the menu in short steps:

### View the temperature

Touch  → Touch  Touch the temperature to see the graphs.

### View the pressure

Touch  → Touch  Touch the pressure to see the graphs.

### Download

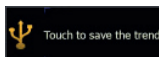
Touch  → Touch  for the download.



### Serial number

Touch  → Touch  .

### Language

Touch  → Touch  → Touch  choose your language.

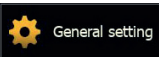
### Date/Time

Touch  → Touch  → Touch  update clock.

### Change of measurement unit from °C to °F, Remote, DEF



Touch  → Touch  → Touch  → Touch  :

Touch the parameter “C” or “F” for make the change.

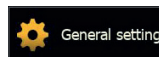

Enable / disable the parameter “Remote ON/OFF” .

Touch “DEF” to restore the parameter.

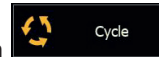
### Switch to “cycling” operation

Touch  → Touch  → Touch  → Touch  change the operation.

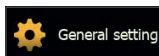
### Drain

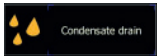
Touch  → Touch  → Touch  → Touch  choose your drain.

### Modbus

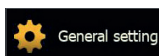
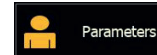
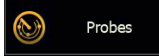

Touch  → Touch  → Touch  → Touch 

### Setting Parameter

Touch  → Touch  → Touch  → Touch  change the

parameter.

### Alarm / warning

Touch  → Touch  to find historical alarm and reset alarm

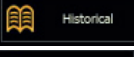
Touch  to see your historical alarm.

Touch  to reset alarm.

## 6 Maintenance

- The machine is designed and built to guarantee continuous operation; however, the life of its components depends on the maintenance performed.
- When requesting assistance or spare parts, identify the machine (model and serial number) by reading the data plate located on the unit.

### 6.1 General instructions

-  Before any maintenance, make sure:
  - the pneumatic circuit is no longer pressurized;
  - the dryer is disconnected from the main power supply

 In case of refrigerant leakage, contact qualified and authorized personnel.

 Always use the Manufacturer's original spare parts: otherwise the Manufacturer is relieved of all liability regarding machine malfunctioning.

 The Schrader valve must only be used in case of machine malfunction: otherwise any damage caused by incorrect refrigerant charging will not be covered by the warranty.

### 6.2 Refrigerant















Charging: any damage caused by incorrect refrigerant replacement carried out by unauthorized personnel will not be covered by the warranty. 

 The equipment contains fluorinated greenhouse gases.  
At normal temperature and pressure, the R513A refrigerant is a colourless gas classified in SAFETY GROUP A1 - EN378 (group 2 fluid according to Directive PED 2014/68/EU) GWP (Global Warming Potential) = 573.

-  In case of refrigerant leakage, ventilate the room.

## 6.3 Preventive Maintenance Programme

To guarantee lasting maximum dryer efficiency and reliability:



Maintenance Activity Description	Maintenance Interval (standard operating conditions)				
	Daily	Weekly	4 Months	12 Months	36 Months
<b>Activity</b> Check  Service 					
Check POWER ON indicator is lit.					
Check control panel indicators.					
Clean the pressostatic valve filter, if it is not dirty increase the inspection interval (see instructions) (PSE750-1800)					
Check condensate drain.					
Clean condenser fins.					
Verify the correct position and operation of the crankcase heater					
Check electrical absorption.					
Check refrigerant leaks.					
Depressurize the dryer. Complete drain maintenance.					
Depressurize the dryer. Replace pre- and post-filter elements.					
Check temperature sensors. Replace if necessary.				 	
Dryer maintenance kit.					

The following are available (see par. 8.4 appendix):

- 3 years preventive maintenance kits;
- service kit
  - compressor kits;
  - fan kits;
  - hot gas valve kits;
  - water condenser kits;
- individual spare parts.

## 6.4 Dismantling

The refrigerant and the lubricating oil contained in the circuit must be recovered in conformity with current local environmental regulations.

 Recycling	Recycling Disposal 
structural work	steel/epoxy-polyester resins
exchanger	aluminium
pipes/headers	copper/aluminium/carbon steel
drain	polyamide
exchanger insulation	EPS (sintered polystyrene)
pipe insulation	synthetic rubber
compressor	steel/copper/aluminium/oil
condenser	copper/aluminium
refrigerant	R513A
valves	brass
electrical cables	copper/PVC

Equipment containing electrical components must be disposed separately collected with electrical and electronic waste according to local and currently legislation.



# 7 Troubleshooting

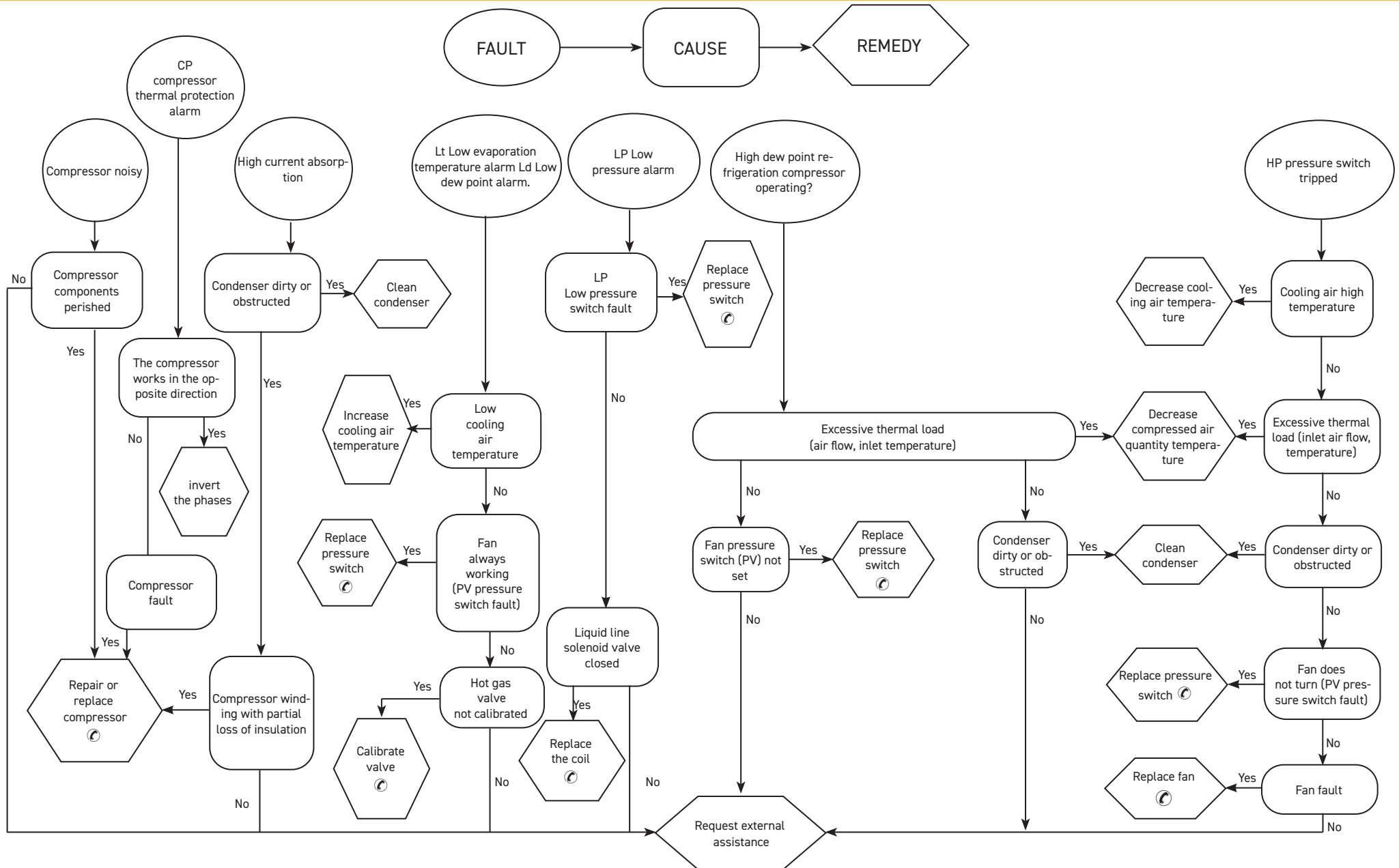



# Índice

<b>1 Seguridad</b>	<b>1</b>
1.1 Importancia del manual.....	1
1.2 Señales de advertencia.....	1
1.3 Instrucciones de seguridad.....	1
1.4 Riesgos residuales.....	2
<b>2 Introducción</b>	<b>2</b>
2.1 Transporte.....	2
2.2 Traslado.....	2
2.3 Inspección.....	2
2.4 Almacenaje.....	2
<b>3 Instalación</b>	<b>3</b>
3.1 Modalidades.....	3
3.2 Espacio operativo.....	3
3.3 Versión condensador.....	3
3.4 Consejos.....	3
3.5 Conexión eléctrica.....	3
3.6 Conexión del drenaje de condensados.....	3
<b>4 Puesta en Marcha</b>	<b>4</b>
4.1 Comprobaciones previas.....	4
4.2 Arranque.....	4
4.3 Funcionamiento.....	4
4.4 Parada.....	4
<b>5 Control</b>	<b>5</b>
5.1 Panel de control.....	5
5.2 Menú principal.....	5
5.2.1 Estado del aparato (I/O).....	5
5.2.2 Presión.....	6
5.2.3 Temperatura.....	6
5.2.4 General.....	7
5.2.4.1 Idioma.....	7
5.2.4.2 Fecha/Tiempo.....	7
5.2.4.3 User menu.....	7
5.2.4.4 Parámetro.....	8
5.2.5 Fecha del número de serie.....	9
5.2.6 Download.....	9
5.3 Alarmas/advertencias.....	10
5.3.1 Lista de alarmas y avisos.....	10
5.4 Menú rápido.....	11
<b>6 Mantenimiento</b>	<b>12</b>
6.1 Advertencias generales.....	12
6.2 Refrigerante.....	12
6.3 Programa de mantenimiento preventivo.....	12
6.4 Desguace.....	13
<b>7 Solución de problemas</b>	<b>14</b>
<b>8 Apéndice</b>	

## 1 Seguridad

### 1.1 Importancia del manual

- Consérvelo durante toda la vida útil del equipo.
- Léalo antes de realizar cualquier operación.
- Puede sufrir modificaciones: para una información actualizada, consulte la versión instalada en el equipo.

### 1.2 Señales de advertencia



Instrucción para evitar peligros personales



Instrucción para evitar que se dañe el equipo





Se requiere la intervención de un técnico experto y autorizado





El significado de los símbolos utilizados se indica en el apartado 8.1

### 1.3 Instrucciones de seguridad

 Antes de realizar cualquier operación de mantenimiento, desconecte siempre la máquina de la red eléctrica. Utilícelo siempre durante el mantenimiento.

 El manual está destinado al usuario final y sólo para las operaciones que pueden realizarse con los paneles cerrados. Las operaciones que requieren la apertura con herramientas deben ser efectuadas por personal experto y calificado.

 No supere los límites de proyecto que se indican en la placa de características.

  El usuario debe evitar cargas distintas de la presión estática interna. En caso de riesgo de fenómenos sísmicos, es necesario proteger adecuadamente la unidad.

 Los dispositivos de seguridad en el circuito de aire comprimido están a cargo del usuario.

 Los dispositivos de seguridad del circuito del aire comprimido se dimensionan teniendo en cuenta las características técnicas del sistema y las normas locales en vigor.  
La unidad debe utilizarse exclusivamente para uso profesional y con el objeto para el cual ha sido diseñada.

El usuario debe analizar todos los aspectos de la aplicación en que el producto se ha instalado, seguir todas las normas industriales de seguridad aplicables y todas las prescripciones relativas al producto descritas en el manual de uso y en la documentación redactada que se adjunta a la unidad.

La alteración o sustitución de cualquier componente por parte del personal no autorizado, así como el uso inadecuado de la unidad eximen de toda responsabilidad al fabricante y provocan la anulación de la garantía.

El fabricante declina toda responsabilidad presente o futura por daños personales o materiales derivados de negligencia del personal, incumplimiento de las instrucciones dadas en este manual o inobservancia de las normativas vigentes sobre la seguridad de la instalación.

El fabricante no asume ninguna responsabilidad por daños debidos a alteraciones y/o modificaciones del embalaje.

El usuario es responsable que las especificaciones suministradas para seleccionar la unidad o sus componentes y/o opciones sean exhaustivas para un uso correcto o razonablemente previsible de la misma unidad o de los componentes.

 **ATENCIÓN:** El fabricante se reserva el derecho de modificar sin previo aviso la información de este manual. Para que la información resulte completa, se recomienda al usuario consultar el fabricante.

## 1.4 Riesgos residuales

Las operaciones de instalación, puesta en marcha, apagado y mantenimiento del equipo deben realizarse de total conformidad con lo indicado en la documentación técnica del equipo y de manera tal que no se genere ninguna situación de riesgo. Los riesgos que no han podido eliminarse con recursos técnicos de diseño se indican en la tabla siguiente

parte del equipo	riesgo residual	modo	precauciones
batería de intercambio térmico	pequeñas heridas cortantes	contacto	evitar el contacto, usar guantes de protección
rejilla del ventilador y ventilador	lesiones	introducción de objetos puntiagudos en la rejilla mientras el ventilador está funcionando	no introducir ni apoyar ningún objeto en la rejilla de los ventiladores
interior del equipo: compresor y tubo de salida	quemaduras	contacto	evitar el contacto, usar guantes de protección
interior del equipo: partes metálicas y cables eléctricos	intoxicación, electrocución, quemaduras graves	defecto de aislamiento de los cables de alimentación que llegan al cuadro eléctrico del equipo; partes metálicas en tensión	protección eléctrica adecuada de la línea de alimentación; conectar cuidadosamente a tierra las partes metálicas
exterior del equipo: zona circundante	intoxicación, quemaduras graves	incendio por cortocircuito o sobrecalentamiento de la línea de alimentación del cuadro eléctrico del equipo	sección de los cables y sistema de protección de la línea de alimentación eléctrica conformes a las normas vigentes

## 2 Introducción

Este manual hace referencia a los secadores frigoríficos diseñados para eliminar el vapor de agua del aire comprimido.

### 2.1 Transporte

El equipo embalado debe mantenerse:

- en posición vertical;
- protegido de los agentes atmosféricos;
- protegido de golpes.

### 2.2 Traslado

Utilice una carretilla elevadora con horquillas, adecuada para el peso del equipo, y evite todo tipo de golpes.

### 2.3 Inspección

- Los equipos salen de fábrica ensamblados, cableados, cargados con refrigerante y aceite, y probados en las condiciones de trabajo nominales.
- Controle el equipo a su llegada y notifique inmediatamente al transportista si nota algún inconveniente.
- Desembale el equipo lo más cerca posible del lugar de instalación.

### 2.4 Almacenaje

Si es necesario apilar varios equipos, respete las indicaciones impresas en el embalaje. Conserve el equipo en un lugar limpio y protegido de la humedad y la intemperie.

## 3 Instalación

☞ Instale en interiores en un área limpia y seca que esté protegida de los elementos, la luz solar directa y / u otras condiciones adversas.

⚠ El producto instalado debe estar adecuadamente protegido contra el riesgo de incendio (ref. EN378-3).

### 3.1 Modalidades

⚠ En los modelos enrosque a tope los prisioneros en las bridas antes de montar las contrabridas (vea el apartado 8.6)

☞ Respete las indicaciones dadas en los apartados 8.2 y 8.3.  
Todos los secadores deben contar con una adecuada prefiltración instalada cerca de la entrada de aire del secador. El vendedor no tendrá ninguna responsabilidad ni obligación de compensación por daño directo o indirecto causado por la ausencia de prefiltración adecuada

☞ El elemento de prefiltro (para filtración de 3 micrones o mejor) debe ser sustituido al menos una vez al año o antes, según las recomendaciones del fabricante.

☞ Conecte correctamente el secador utilizando las bocas de entrada y salida del aire comprimido.

### 3.2 Espacio operativo

☞ Deje un espacio libre de 1.5 m todo alrededor del equipo.  
En los modelos con expulsión vertical del aire de condensación, deje 2 m libres sobre el secador.

### 3.3 Versión condensador

#### Versión por aire (Ac)

No cree situaciones que permitan la recirculación del aire de enfriamiento.  
No obstruya las rejillas de ventilación.

#### Versión por agua (Wc)

Si el suministro no lo incluye, instale un filtro de malla en la entrada del agua de condensación.

☞ Características del agua de condensación utilizada

Temperatura	≥50°F (10°C)	CL <sup>-</sup>	<50 ppm
ΔT IN/OUT	5-15°C	CaCO <sub>3</sub>	70-150 ppm
Max % de glicol	50	O <sub>2</sub>	<0.1 ppm
Presión	43.5-145 PSig (3-10 barg)	Fe	<0.2 ppm
PH	7.5-9	NO <sub>3</sub>	<2 ppm
Conductividad eléctrica	10-500 μS/cm	HCO <sub>3</sub> <sup>-</sup>	70-300 ppm
Índice de saturación de Langelier	0-1	H <sub>2</sub> S	<0.05 ppm
SO <sub>4</sub> <sup>2-</sup>	<50 ppm	CO <sub>2</sub>	<5 ppm
NH <sub>3</sub>	<1 ppm	Al	<0.2 ppm

Es posible que los materiales estándar previstos para el condensador no sean adecuados para determinadas aguas de refrigeración (desionizada, desmineralizada, destilada). En estos casos, se ruega ponerse en contacto con el fabricante.

### 3.4 Consejos

A fin de proteger los componentes internos del secador y del compresor de aire, no instale el equipo donde el aire circundante contenga contaminantes sólidos o gaseosos, en particular azufre, amoníaco y cloro. Evite también la instalación en ambiente marino.

En las versiones con ventiladores axiales, se desaconseja canalizar el aire agotado.

### 3.5 Conexiónado eléctrico

Utilice un cable homologado con arreglo a las reglamentaciones locales (para la sección mínima del cable, vea el apartado 8.3).

Instale un interruptor magnetotérmico diferencial aguas arriba del equipo (RCCB - IDn = 0,3 A) con distancia 3 mm entre los contactos cuando el interruptor está abierto (consulte las disposiciones locales al respecto).

La corriente nominal "In" de dicho magnetotérmico debe ser igual a FLA y la curva de intervención de tipo D.

Seleccione la fuente de alimentación e inserte un puente como se muestra a continuación:

S7-S6 por 400/3/50

S8-S6 por 460/3/60

Dentro del cuadro eléctrico hay una etiqueta de instrucciones.

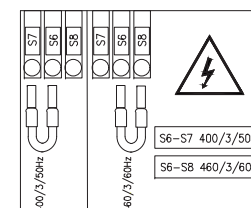

### 3.6 Conexión del drenaje de condensados

☞ Para conectar el equipo al sistema de drenaje, evite la conexión en circuito cerrado en común con otras líneas de descarga presurizadas. Compruebe que los condensados fluyan correctamente. Deseche los condensados con arreglo a las normas medioambientales vigentes.

## 4 Puesta en Marcha

### 4.1 Comprobaciones previas

Antes de poner en marcha el secador, asegúrese de que:

- a instalación haya sido realizada de acuerdo con lo expuesto en la sección 3;
- las válvulas de entrada del aire están cerradas y no hay flujo de aire en el secador;
- el suministro eléctrico es correcto;
- con la versión Wc, abra el circuito de agua de refrigeración durante unos minutos antes de encender el secador.



### 4.2 Arranque

1. encienda la alimentación girando el INTERRUPTOR

PRINCIPAL  "a "I ON". aparece esta información:

 **LA RESISTENCIA DEL CÁRTER DEBE ACTIVARSE 12 HORAS ANTES DE PONER EN MARCHA EL SECADOR.**

Después, toque para entrar al panel de control.

2. toque  para arrancar, el botón cambia de atenuado a verde, para indicar que ahora el secador está en funcionamiento .

3. Encienda el secador antes que el compresor de aire;  
El incumplimiento de esta regla puede causar daños graves al compresor.

 Ventiladores (versión Ac): si están conectados con la secuencia de fase incorrecta, girarán en dirección opuesta con riesgo de dañarse (en este caso el aire saldrá del armario del secador por las rejillas del condensador en vez de por la rejilla del ventilador - consulte el párr. 8.6 y 8.7 para el flujo de aire correcto); invierta inmediatamente las dos fases.

4. Espere 5 minutos y después abra lentamente la válvula de entrada de aire;
5. abra lentamente la válvula de salida de aire: ahora el secador está secando.

#### Monitor de fase

Si aparece la alarma "Monitor de fase" en la pantalla durante el arranque del secador, el usuario deberá revisar el cableado de los terminales de entrada del interruptor de desconexión del secador.

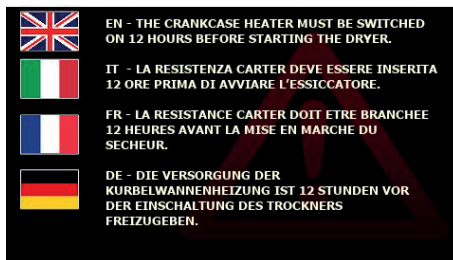

### 4.3 Funcionamiento

- Deje el secador en marcha durante todo el periodo de funcionamiento del compresor de aire;
- El secador funciona en modo automático, por lo tanto, no es necesario realizar ajustes en el lugar de trabajo;
- En caso de producirse flujos de aire excesivos e inesperados, haga una derivación para no sobrecargar el secador.
- Evite las fluctuaciones de temperatura en el aire de entrada.



### 4.4 Parada

1. Detenga el secador 2 minutos después de que se detenga el compresor de aire o, en todo caso, después de la interrupción del flujo de aire;
2. asegúrese de que el aire comprimido no entra en el secador cuando este se encuentre desconectado o si ocurre una alarma.

3. Pulse  para apagar el secador. El botón cambia a atenuado .
4. Gire el INTERRUPTOR PRINCIPAL "  " a "O OFF" para desconectar la alimentación.

 Versión Wc: cierre el circuito de agua con el secador apagado.

## 5 Control

### 5.1 Panel de control

Botones táctiles	Función
	Secador OFF (atenuado)
	Secador ON (verde)

LOCAL = Local configuración  
REMOTE = Remote configuración

Función
<p>Velocidad de funcionamiento del ventilador (solo para la versión con condensador de aire)</p>
<p>Velocidad de funcionamiento de la válvula de gas caliente</p>
<p>ahorro de energía % (ciclos)</p>

Botones táctiles	Función
	Access to information menu: machine status, pressures, temperatures, general settings, consumption, user password
	Gray = no alarm Red = warning Flashing Red = Alarm
	Dryer OFF = grey light Cycling active = flashing green Compressor active = light blue
	grey = Condensate drain OFF green = Condensate drain ON

Función
<p>Tendencia de punto de condensación</p>

Botones táctiles	Función
	Toque: para un drenaje manual

### 5.2 Menú principal

Toque para acceder al menú de "Información":  
 Cuando se toca uno de los "botones táctiles", durante unos segundos se ilumina el contorno para confirmar que se realizó la selección.  
 Esto se aplica a cada "botón táctil" presente en el panel de control.  
 Toque para volver al panel de control.

#### 5.2.1 Estado del aparato (I/O)

Toque para acceder al menú de "estado del aparato".  
 Esta es la lista de entradas:  
 Un LED al lado de la descripción indica lo siguiente sobre las protecciones / funciones / configuración:  
 activo = luz verde  
 inactivo = atenuado.  
 Toque para acceder a la siguiente página.

Esta es la lista de salidas:

Toque para volver al menú anterior.

## 5.2.2 Presión

Toque  para acceder al menú de "presión" y visualizar lo siguiente: presión de condensación, velocidad de funcionamiento del ventilador, presión de evaporación, velocidad de funcionamiento de la válvula de gas caliente.

Toque em um parâmetro específico para visualizar sua tendência de dados de desempenho ao longo do tempo.

Por ej., "Presión de condensación/evaporación"

Utilice  y  para desplazarse por el gráfico.

Toque  para volver al menú anterior.

Por ej., "Velocidad de funcionamiento de la válvula de gas caliente/ventilador"

Utilice  y  para desplazarse por el gráfico.

Toque  para volver al menú anterior.

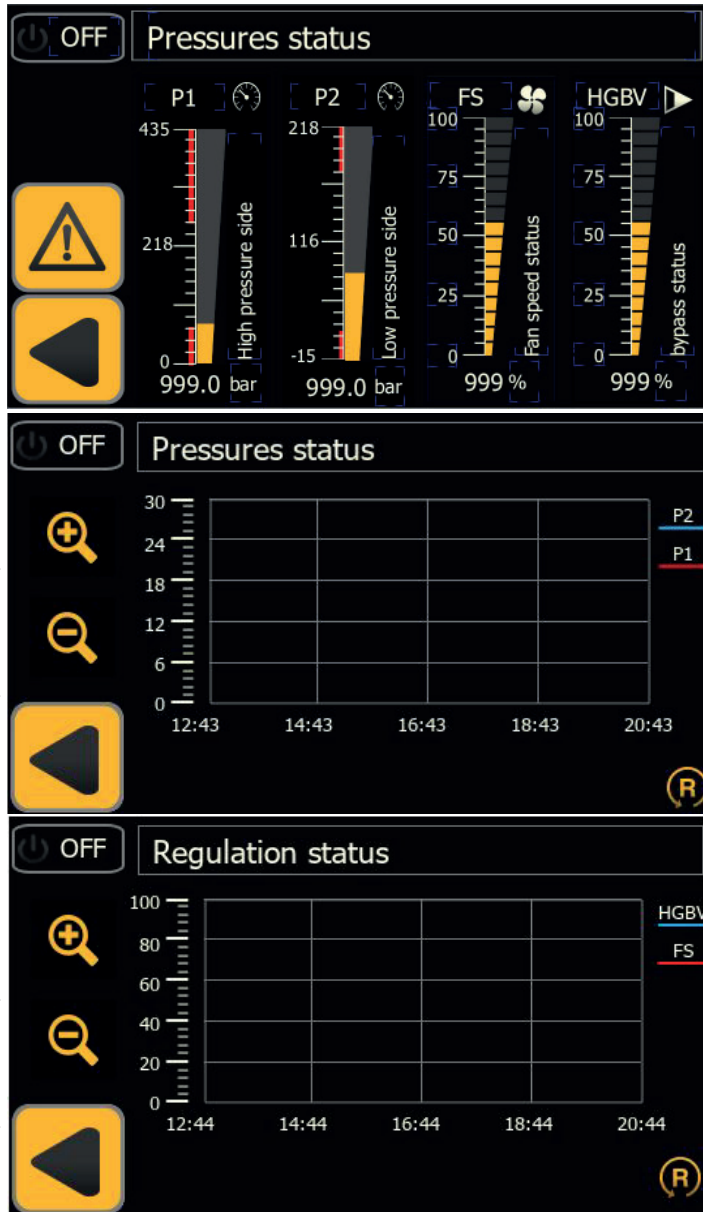

## 5.2.3 Temperatura

Toque  para visualizar las lecturas de temperatura de las sondas de temperatura del diagrama de circuito.



Toque  para acceder a la siguiente página.

B4 = Activa solo para la versión Multi-cooler.

Toque em um dos valores de temperatura de baixa pressão para ver uma tendência de dados de todas as sondas no circuito de baixa pressão.



Toque em um dos valores de temperatura de alta pressão para ver uma tendência de dados de todas as sondas no circuito de alta pressão.

Temperatura - baja presión circuito

Utilice  y  para desplazarse por el gráfico.

Toque  para volver al menú anterior.

Temperatura - alta presión circuito

Utilice  y  para desplazarse por el gráfico.

Toque  para volver al menú anterior.

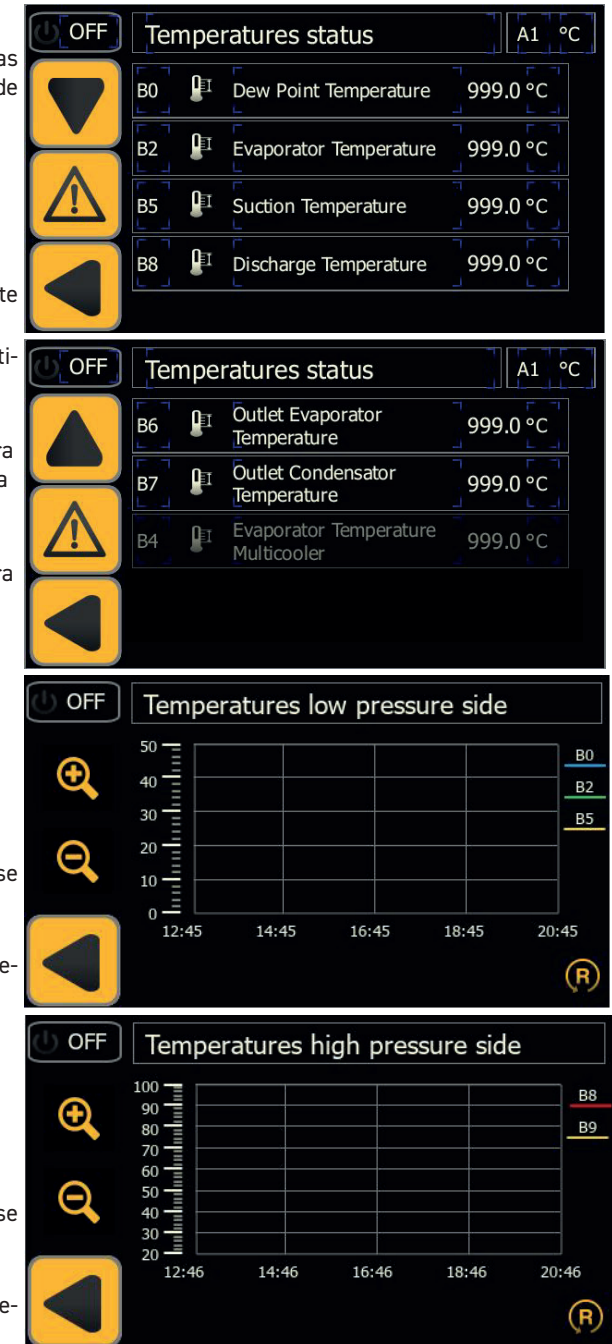

## 5.2.4 General

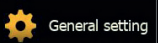
Toque  para acceder a un menú "general" con las siguientes secciones: idioma; fecha/hora; parámetro; mantenimiento; ciclos/funcionamiento continuo.

toque em qualquer menú para visualizar / ajustar. .

Toque  para volver al panel de control.

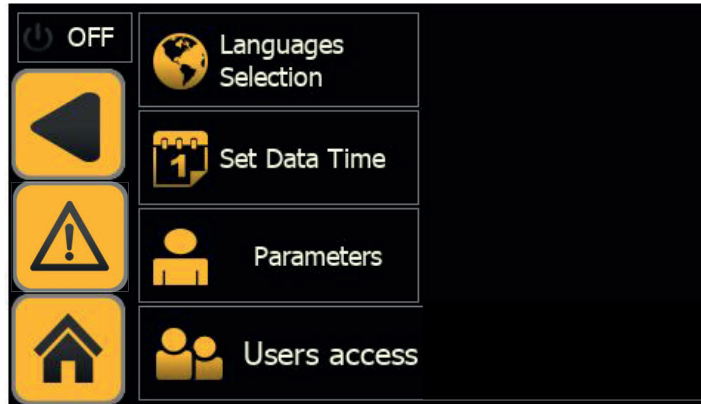

### 5.2.4.1 Idioma

Toque  para acceder al menú de idioma. Toque en el idioma que necesite. Volverá automáticamente al menú principal con el idioma que haya elegido.

Toque  para volver al menú anterior.

Toque en el idioma que necesite. Volverá automáticamente al menú principal con el idioma que haya elegido.

Toque  para volver al menú anterior.



## 5.2.4.2 Fecha/Tiempo

Toque  para acceder al menú de "fecha/tiempo".

Toque Fecha/Tiempo para proceder con el cambio.

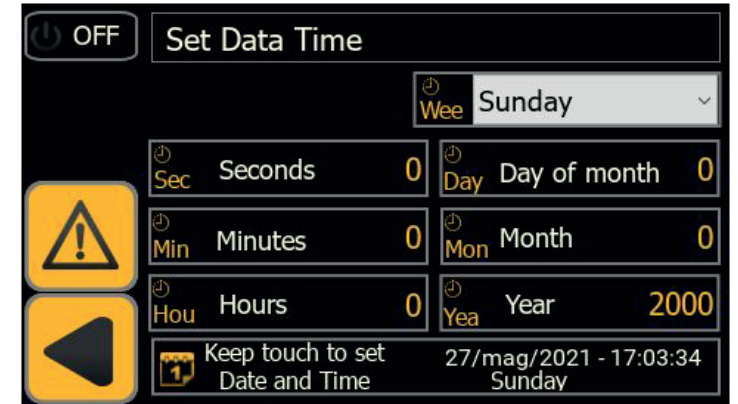

Presione durante 2 segundos  27/mag/2021 - 17:03:34 Sunday para confirmar.

Toque  para volver al menú anterior.

### 5.2.4.3 User menu

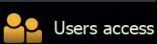
Toque  para acceder al menú de "User".

Esto menú está reservado para el técnico de servicio de Parker.

User name:

Password:

Show password

#### 5.2.4.4 Parámetro

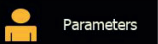
Toque  para acceder al menú de "parámetros" con las siguientes secciones: sondas, descarga de condensado, configuración, mantenimiento, ciclos.

Toque el "botón táctil" para acceder al menú.

Toque  para volver al menú anterior.

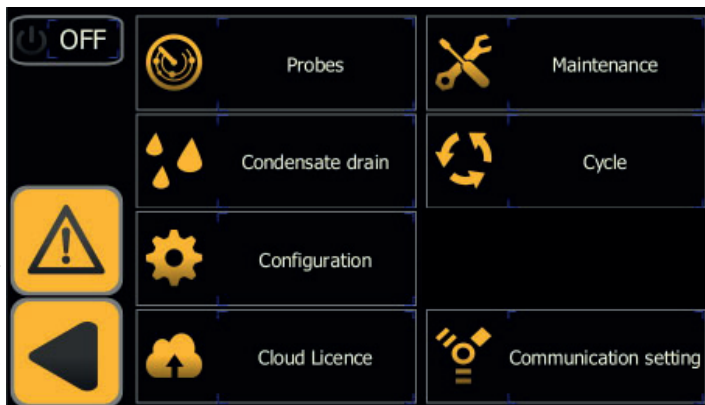

#### Sondas

Toque  para ajustar las advertencias, los retrasos o el límite mínimo/máximo del punto de condensación.

Toque  para volver al menú anterior.

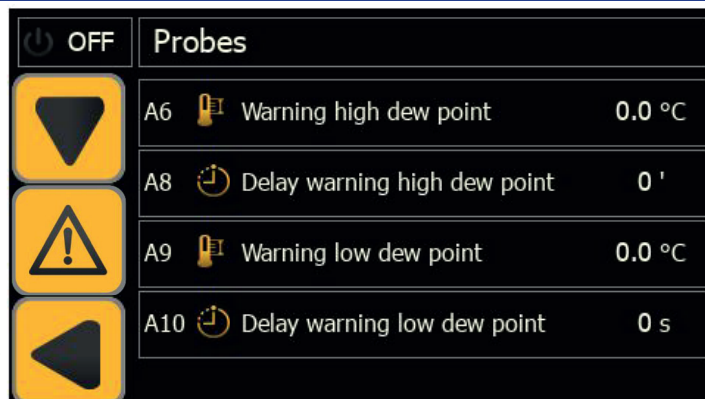

#### Descarga de condensado

Touch  para acceder al menú de "descarga de condensado".

Puede elegir lo siguiente:

1. Descarga temporizada (selección de los tiempos de cierre y apertura);
2. Descarga capacitiva;
3. Descarga continua (externa).

Toque  para volver al menú anterior.

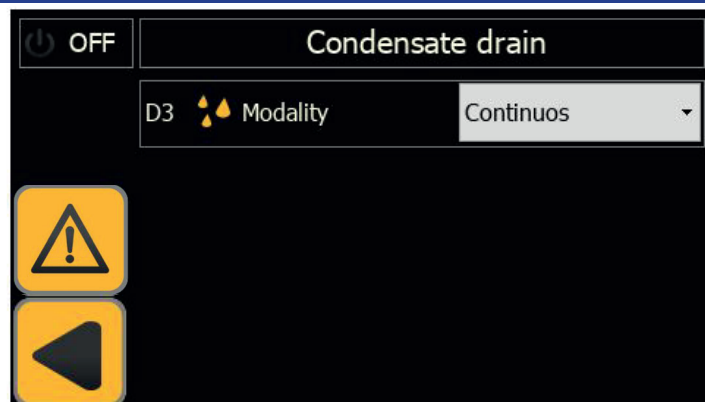

#### Configuración

Toque  para acceder a la pantalla de configuración con el siguiente menú:

1. selección de la medida de temperatura °C / °F;
2. activación del control remoto;
3. activación solo de alarmas o de alarmas / advertencias;
4. restablecimiento a los parámetros predeterminados.

Utilice el "botón táctil" al lado de la descripción para seleccionar.

 Para administrar el modo REMOTE OFF, retire el puente entre los terminales: 87-92 y conecte el interruptor de arranque / parada remoto (a ser proporcionado por el cliente).

#### Mantenimiento

Toque  para ver las horas de funcionamiento del compresor/secador.

Toque  para volver al menú anterior.

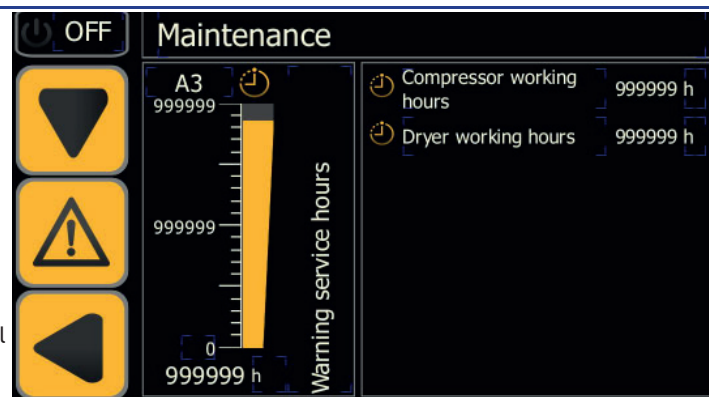
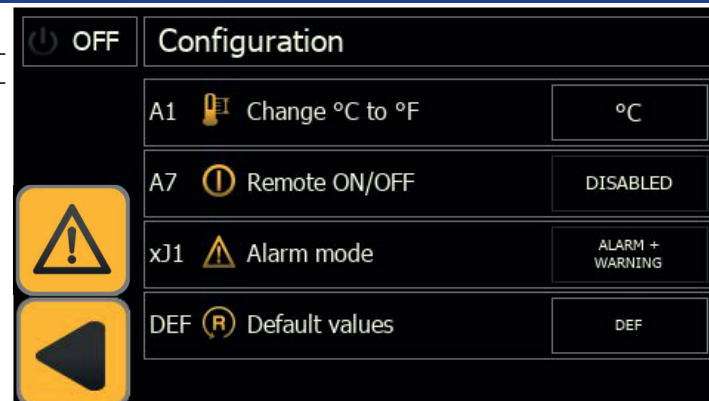

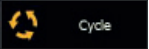

## Funcionamiento

Toque  para elegir el tiempo de funcionamiento: continuo; por ciclos (ahorro de energía).  
Utilice el "botón táctil" al lado de la descripción para seleccionar.

Toque  para volver al menú anterior.

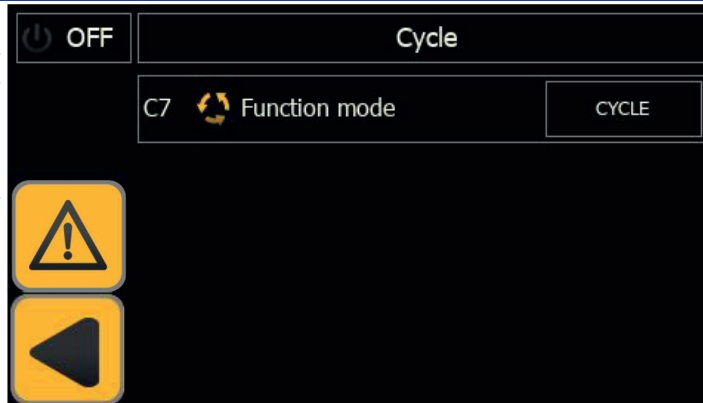

## Modbus

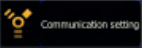
Touch  para configurar los parámetros de Modbus.  
MODBUS RTU  
(RS485)

Toque  para acceder a la siguiente página.

MODBUS TCP/IP

Toque  para volver al menú anterior.

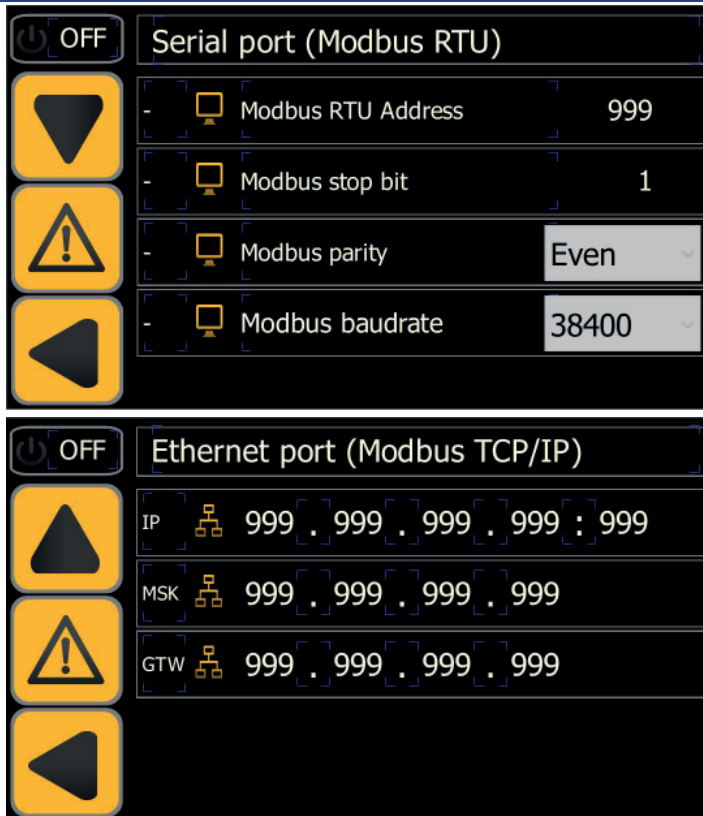

Detener/enciender el secador para confirmar.

## Cloud

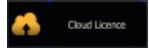
Toque  para ver "password" para cloud.

Esta opción está en marcha.

Toque  para volver al menú anterior.

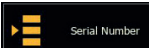

### 5.2.5 Fecha del número de serie

Toque  para acceder al menú de "Serial number".

Toque  para volver al panel de control.

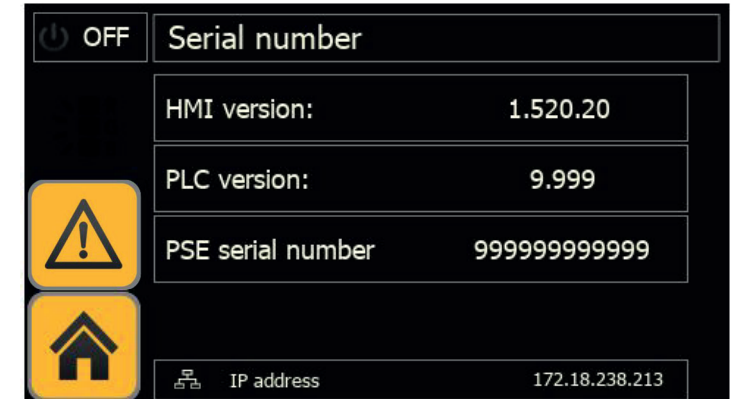

### 5.2.6 Download

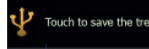
Inserte el USB y toque  para proceder con la descarga de los gráficos de temperaturas y presiones.

Use un USB con led, que muestra a fase de download.

Toque  para volver al menú anterior.

## 5.3 Alarmas/advertencias

Toque  para acceder al menú de “alarmas/advertencias”:

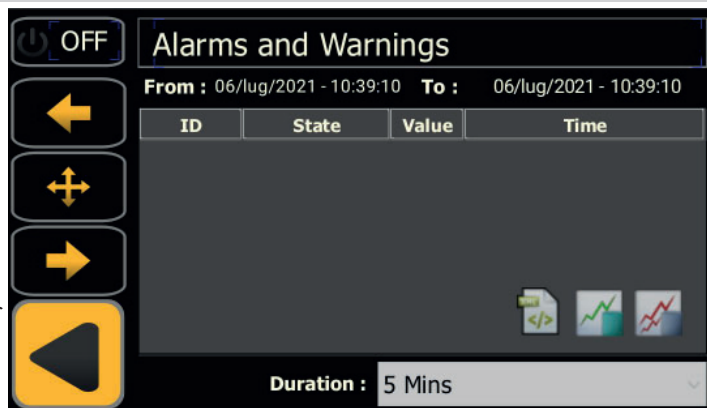

Toque “duration” para cambiar el tiempo de la investigación.

Cuando se han restablecido las condiciones de funcionamiento nominales, algunas advertencias y alarmas se reinician automáticamente; es necesario restablecer manualmente las demás alarmas/advertencias.

Toque  para reiniciar la alarma.

Toque  para ver el historial de alarmas con:

código de alarma, fecha, número de alarmas, posición de la secuencia, y hora de activación de las alarmas..

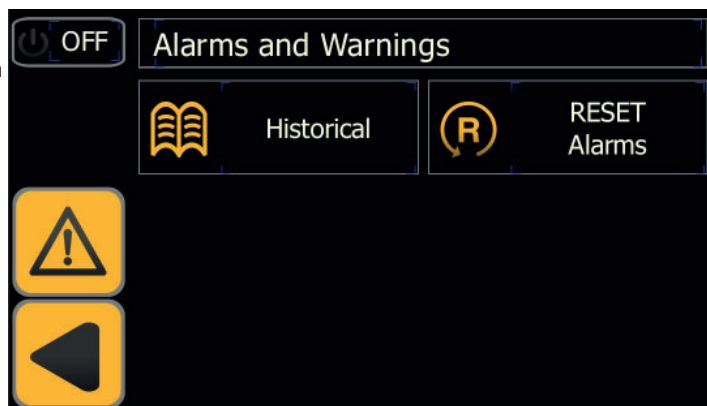

Toque  para volver al menú anterior.

### 5.3.1 Lista de alarmas y avisos

a = alarma; w = aviso

Code	Alarmas/Avisos	Causa
aLD	alarma Bajo punto de rocío	temperatura B0<A9 por más de A10 segundo .
aLT	alarma baja temperatura de evaporación	temperatura B2<A12 por más de A13 segundo
aHT2	alarma alta temperatura de descarga	temperatura B8>A11
aHP	alarma alta presión	presostato de alta presión activado
aLP	alarma baja presión	presostato de baja presión activado
aLTA	alarma baja temperatura multicooter	temperatura B4<A12 por más de A13 segundo
aPI*	compressor thermal Protection alarm	thermal Protection compressor activado
aPH	alarma monitor de fase	monitor de fase activado (solo para 460-750)
aCM1	alarma comunicación de la expansión 1	la expansión 1 no comunica
aCM2	alarma comunicación de la expansión 2	la expansión 2 no comunica
wB0	aviso sonda B0	sonda rota o no conectada
wB2	aviso sonda B2	sonda rota o no conectada
wB4	aviso sonda B4	sonda rota o no conectada
wB5	aviso sonda B5	sonda rota o no conectada
wB6	aviso sonda B6	sonda rota o no conectada
wB8	aviso sonda B8	sonda rota o no conectada
aFP1	aviso alta presión transmisor P1	transmisor rota o no conectada
wHD	aviso alto de punto de rocío	temperatura B0>A6 por más de A8 minutos
wHT1	aviso alta temperatura de descarga	temperatura B8>A14 por más de A15 minutos
wHP1	aviso alta presión	presión P1>A16 por más de 2 segundo
wHB5	aviso alta temperature de entrada	tempertura B5>A18 por más de 1 minuto
wLP2	aviso baja presión	presión P2<A21 por más de 150 segundos
wSR	Aviso Mantenimiento programado	tiempo de servicio transcurrido
wDR1	aviso drenaje de condensados 1	drenaje de condensados de secador 1 no descarga
wDR2	aviso drenaje de condensados 2	drenaje de condensados de secador 2 no descarga
wDR3	aviso drenaje de condensados 3	drenaje de condensados de secador 3 no descarga
aFP2	aviso baja presión transmisor P2	transmisor rota o no conectada

\* para los modelos 900-1800 la alarma también puede tener el significado de fases invertidas.

## 5.4 Menú rápido

Acceda al menú mediante pasos rápidos:

### Visualizar la temperatura

Toque  → Toque  Toque la temperatura para ver los gráficos.

### Visualizar la presión

Toque  → Toque  Toque la presión para ver los gráficos.

### Download

Toque  → Toque  para la descarga.



### Serial number

Toque  → Toque 

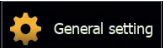
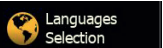
### Cambiar el idioma

Toque  → Toque  → Toque  para elegir el idioma.

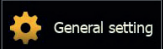
### Fecha/Tiempo

Toque  → Toque  → Toque  para actualizar el reloj.

### Cambiar las unidades de medida de °C a °F, Remote, DEF



Toque  → Toque  → Toque  → Toque  :

Toque el parámetro “°C” o “°F” para realizar el cambio.



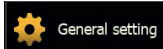

Habilita/deshabilita el parámetro “Remote ON/OFF” .

Toque “DEF” para restaurar el parámetro.

### Cambiar a funcionamiento “por ciclos”

Toque  → Toque  → Toque  → Toque  para cambiar el funcionamiento.

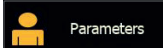

### Descarga

Toque  → Toque  → Toque  → Toque  para elegir la descarga.

### Modbus

Toque  → Toque  → Toque  → Toque 

### Ajustar los parámetros

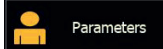
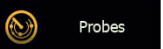
Toque  → Toque  → Toque  → Toque  para cambiar el parámetro.

## Alarma / advertencia

Toque  → Toque  para encontrar la alarma histórica y restablecer la alarma.

Toque  para ver los datos históricos.

Toque  para restablecer la alarma.

## 6 Mantenimiento

• El aparato ha sido diseñado y fabricado para garantizar un funcionamiento continuo; No obstante, la vida útil de sus componentes depende del mantenimiento que se realice.

-  Cuando pida ayuda o piezas sueltas, identifique el aparato (modelo y número de serie) leyendo la placa de datos ubicada en la máquina.

### 6.1 Advertencias generales

 Antes de realizar cualquier operación de mantenimiento, compruebe que:

- el circuito neumático no esté a presión,
- el secador esté desconectado de la red eléctrica.

 El uso de repuestos no originales exime al fabricante de toda responsabilidad por el mal funcionamiento del equipo.

 En caso de pérdida de refrigerante, llame a un técnico experto y autorizado.

 La válvula Schrader debe utilizarse sólo en caso de funcionamiento anómalo del equipo; de lo contrario, los daños causados por una carga incorrecta de refrigerante no serán reconocidos en garantía.

### 6.2 Refrigerante

Operación de carga: los daños causados por una carga del refrigerante incorrecta realizada por personal no autorizado no serán reconocidos en garantía. 

 El aparato contiene gases fluorados de efecto invernadero.

El fluido refrigerante R513A, a temperatura y presión normales, es un gas incoloro perteneciente al SAFETY GROUP A1 - EN378 (fluido del grupo 2 según la directiva PED 2014/68/UE); GWP (Global Warming Potential) = 573.

 En caso de fuga de refrigerante, airee el local.

## 6.3 Programa de mantenimiento preventivo

Para garantizar la máxima eficiencia y fiabilidad del secador a lo largo del tiempo, lleve a cabo:



Acciones de mantenimiento	Intervalo de tiempo (condiciones de funcionamiento estándar)				
	Diarias	Semanales	4 Meses	12 Meses	36 Meses
Comprobar que el indicador POWER ON está encendido.					
Comprobar todos los indicadores del panel de control.					
Limpiar el filtro de la válvula presostática de agua, si no está sucio aumentar el intervalo de inspección (ver instrucciones) (PSE750-1800)					
Comprobar el purgador.					
Limpiar el condensador, rejilla y conexiones.					
Comprobar que la posición/ operación de la resistencia del cárter sea correcta					
Comprobar el consumo eléctrico.					
Comprobar las pérdidas de refrigerante.					
Despresurizar la instalación. Hacer mantenimiento integral del purgador.					
Despresurizar la instalación. Sustituir todos los elementos filtrantes de los filtros instalados.					
Comprobar las sondas de temperatura. Sustituir si fuera necesario.				 	
Conjunto de mantenimiento del secador.					

Están disponibles (apartado 8.4):

- kits de mantenimiento preventivo de los 3 años;
- kits de servicio
  - kits compresor
  - kits ventilador
  - kits de válvula gas caliente
  - Kits de condensador de agua
- piezas de repuesto individuales.

## 6.4 Desguace

El fluido refrigerante y el aceite lubricante contenidos en el circuito deben recogerse de conformidad con las normas locales.

	<b>Reciclaje Desecho</b> 
estructura	acero/resinas epoxi-poliéster
intercambiador	aluminio
tuberías/colectores	cobre/aluminio/acero al carbono
drenaje condensados	polyamide
aislamiento intercambiador	EPS (poliestireno sinterizado)
aislamiento tuberías	caucho sintético
compresor	acero/cobre/aluminio/aceite
condensador	cobre/aluminio
refrigerante	R513A
válvulas	latón
cables eléctricos	cobre/PVC

Los equipos que contengan componentes eléctricos deben eliminarse por separado junto con los residuos eléctricos y electrónicos de acuerdo con la legislación local y vigente.



# 7 Solución de problemas

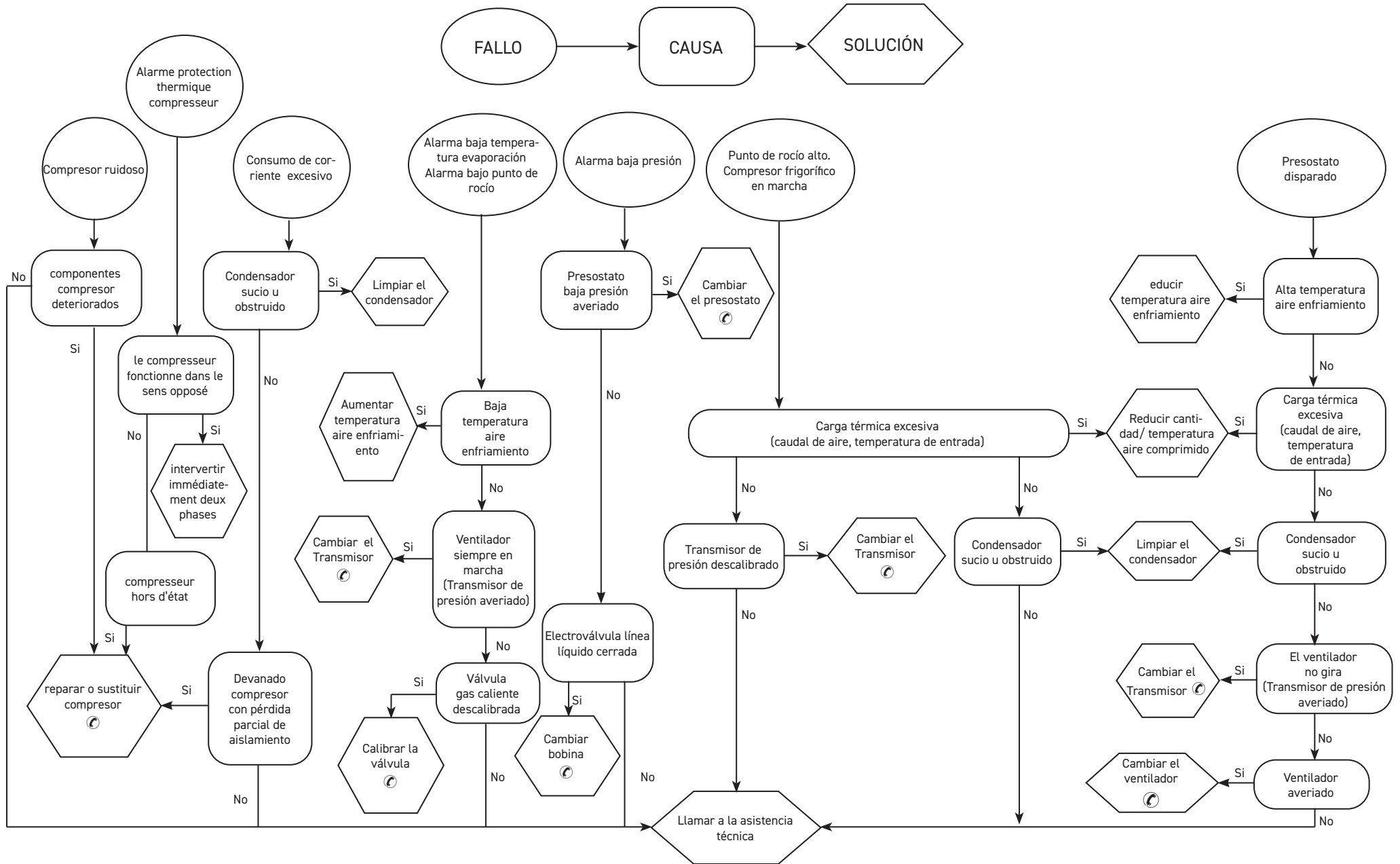

## Sommaire

<b>1 Sécurité</b>	<b>1</b>
1.1 Importance de la notice.....	1
1.2 Signaux d'avertissement.....	1
1.3 Consignes de sécurités.....	1
1.4 Risques résiduels.....	2
<b>2 Introduction</b>	<b>2</b>
2.1 Transport.....	2
2.2 Manutention.....	2
2.3 Inspection ou visite.....	2
2.4 Stockage.....	2
<b>3 Installation</b>	<b>3</b>
3.1 Procédure.....	3
3.2 Espace de travail.....	3
3.3 Version condenseur.....	3
3.4 Recommandations.....	3
3.5 Raccordement électrique.....	3
3.6 Raccordement purgeur des condensats.....	3
<b>4 Mise en service</b>	<b>4</b>
4.1 Contrôles préliminaires.....	4
4.2 Démarrage.....	4
4.3 Fonctionnement.....	4
4.4 Arrêt.....	4
<b>5 Commande</b>	<b>5</b>
5.1 Panneau de commande.....	5
5.2 Menu principal.....	5
5.2.1 État de la machine (E/S).....	5
5.2.2 Pression.....	6
5.2.3 Température.....	6
5.2.4 Général.....	7
5.2.4.1 Langue.....	7
5.2.4.2 Date/Temps.....	7
5.2.4.3 Menu User.....	7
5.2.4.4 Paramètre.....	8
5.2.5 Date du numéro de série.....	9
5.2.6 Télécharger.....	9
5.3 Alarmes/Avertissements.....	10
5.3.1 Liste des alarmes/avertissement.....	10
5.4 Menu Rapide.....	11
<b>6 Entretien</b>	<b>12</b>
6.1 Recommandations générales.....	12
6.2 Réfrigérant.....	12
6.3 Programme d'entretien préventif.....	12
6.4 Mise au rebut.....	13
<b>7 Dépannage</b>	<b>14</b>
<b>8 Appendice</b>	

## 1 Sécurité

### 1.1 Importance de la notice

- La notice doit être conservée pendant toute la durée de vie de la machine.
- Lire la notice avant toute opération ou intervention.
- La notice est sujette à modifications : pour une information actualisée, consulter la version à bord de la machine.

### 1.2 Signaux d'avertissement



Instructions pour éviter de faire courir des risques aux personnes



Instructions à suivre pour éviter de faire subir des dégâts à l'appareil.





La présence d'un professionnel qualifié et agréé est exigée





Sont présents des symboles dont la signification est donnée au paragraphe 9.1

### 1.3 Consignes de sécurités

 Chaque unité est munie d'un sectionneur électrique pour permettre toute intervention en conditions de sécurité. Toujours actionner ce dispositif pour éliminer les risques pendant les opérations d'entretien.

 La notice s'adresse à l'utilisateur final uniquement pour les opérations pouvant être effectuées panneaux fermés ; par contre, les opérations qui nécessitent l'ouverture avec des outils doivent être confiées à un professionnel expert et qualifié.

 Ne pas dépasser les limites définies par le projet, qui sont indiquées sur la plaque des caractéristiques.

 Il incombe à l'utilisateur d'éviter des charges différentes de la pression statique interne. En cas de risque d'activité sismique, l'unité doit être convenablement protégée.

 Les dispositifs de sécurité sur le circuit d'air sont à la charge de l'utilisateur.

 Le dimensionnement des dispositifs de sécurité du circuit de l'air comprimé doit être réalisé en tenant compte des caractéristiques techniques de l'installation et de la réglementation locale en vigueur. N'utiliser l'unité que pour un usage professionnel et pour la destination prévue par le constructeur. Il incombe à l'utilisateur d'analyser tous les aspects de l'application pour laquelle l'unité est installée, de suivre toutes les consignes industrielles de sécurité applicables et toutes les prescriptions inhérentes au

produit contenues dans le manuel d'utilisation et dans toute autre documentation réalisée et fournie avec l'unité. La modification ou l'adaptation ou le remplacement d'un composant quelconque par une personne non autorisée et/ou l'usage impropre de l'unité dégagent le constructeur de toute responsabilité et comportent l'annulation de la garantie.

Le constructeur ne saurait être tenu pour responsable pour tous les dommages matériels aux choses ou à l'unité et pour tous les dommages physiques aux personnes dérivant d'une négligence des opérateurs, du non-respect de toutes les instructions de la présente notice, de l'inapplication des normes en vigueur concernant la sécurité de l'installation.

La responsabilité du constructeur est dérogée pour tous les dommages ou dégâts éventuels pouvant résulter de manipulations malveillantes et/ou de modifications de l'emballage.

L'utilisateur doit s'assurer que les conditions fournies pour la sélection de l'unité ou de ses composants et/ou options sont parfaitement conformes pour une utilisation correcte de cette même unité ou de ses composants.

 **ATTENTION: Le fabricant se réserve le droit de modifier sans aucun préavis les informations contenues dans ce manuel. Afin de disposer d'informations complètes et actualisées, il est recommandé à l'utilisateur de consulter le fabricant.**

## 1.4 Risques résiduels

L'installation, la mise en marche, l'arrêt et l'entretien de la machine doivent être effectués conformément aux dispositions prévues par la documentation technique du produit et, quoiqu'il en soit, de manière à ne créer aucune situation de risque.

Les risques n'ayant pu être éliminés en phase de conception sont indiqués dans le tableau suivant.

partie concernée	risque résiduel	modalité	précautions
batterie d'échange thermique	petites coupures	contact	éviter tout contact, porter des gants de protection
grille ventilateur et ventilateur	lésions	introduction d'objets pointus à travers la grille lors du fonctionnement du ventilateur	n'introduire aucune sorte d'objets dans la grille des ventilateurs et ne poser aucun objet sur les grilles
partie interne de l'unité : compresseur et tuyau de refoulement	brûlures	contact	éviter tout contact, porter des gants de protection
partie interne de l'unité : parties métalliques et câbles électriques	intoxications, brûlures graves	incendie dû à un court-circuit ou une surchauffe de la ligne d'alimentation en amont du tableau électrique de l'unité	section des câbles et système de protection de la ligne d'alimentation électrique conformes aux normes en vigueur
partie externe de l'unité : zone environnante de l'unité	intoxications, brûlures graves	incendie dû à un court-circuit ou une surchauffe de la ligne d'alimentation en amont du tableau électrique de l'unité	section des câbles et système de protection de la ligne d'alimentation électrique conformes aux normes en vigueur

## 2 Introduction

Ce manuel fait référence aux sècheurs frigorifiques conçus pour éliminer la vapeur d'eau de l'air comprimé.

### 2.1 Transport

L'unité emballée doit rester :

- en position verticale ;
- à l'abri des intempéries ;
- à l'abri des chocs.

### 2.2 Manutention

Utiliser un chariot élévateur d'une capacité suffisante à soulever le poids de la machine. Éviter tous chocs pendant la manutention.

### 2.3 Inspection ou visite

- En usine, toutes les unités sont assemblées, câblées, chargées avec du réfrigérant et de l'huile et testées dans les conditions de travail normales ;
- après réception de la machine, l'examiner soigneusement pour vérifier son état : recourir contre le transporteur pour les dommages éventuellement survenus au cours du transport ;
- débarrasser l'unité le plus près possible de son lieu d'implantation.

### 2.4 Stockage

En cas d'empilage de plusieurs unités, suivre les instructions inscrites sur l'emballage. Conserver l'unité dans son emballage en un lieu propre et à l'abri de l'humidité et des intempéries.



## 3 Installation

☞ Installez à l'intérieur dans un endroit propre et sec qui est protégé des éléments, de la lumière directe du soleil et / ou d'autres conditions difficiles.

⚠ Le produit installé doit être convenablement protégé contre les risques d'incendie (réf. EN378-3).

### 3.1 Procédure

⚠ Pour les modèles s'assurer de visser les prisonniers ou goujons dans les brides jusqu'à fond de course avant de raccorder les contre-brides (voir paragraphe 8.6).

☞ Respecter les indications des paragraphes 8.2 et 8.3.

Tous les sècheurs doivent être équipés d'une préfiltration adéquate située à immédiate proximité de l'entrée du sécheur. Le revendeur se dégage de toute responsabilité en cas de dommage direct ou indirect causé par l'absence de ce préfiltre.

☞ L'élément préfiltrant (filtration des particules de 3 microns minimum) doit être remplacé une fois par an ou plus, selon les recommandations du fabricant.

☞ Connecter correctement le sécheur aux prises d'entrée et de sortie de l'air comprimé.

### 3.2 Espace de travail

☞ Prévoir un espace de dégagement de 1.5 m autour de l'unité.

Laisser 2 m d'espace au-dessus du sécheur pour les modèles à évacuation verticale de l'air de refroidissement.

### 3.3 Version condenseur

#### Version à air (Ac)

Ne pas créer des situations de recyclage de l'air de refroidissement.

Ne pas obstruer les grilles de ventilation.

#### Version à eau (Wc)

Si la fourniture ne le prévoit pas, monter une crépine sur l'entrée de l'eau de condensation.



Caractéristiques de l'eau de condensation en entrée :

Température	≥50°F (10°C)	CL <sup>-</sup>	<50 ppm
ΔT IN/OUT	5-15°C	CaCO <sub>3</sub>	70-150 ppm
Max % glycole	50	O <sub>2</sub>	<0.1 ppm
Pression	43.5-145 PSIG (3-10 barg)	Fe	<0.2 ppm
PH	7.5-9	NO <sub>3</sub>	<2 ppm
Conductivité électrique	10-500 μS/cm	HCO <sub>3</sub> <sup>-</sup>	70-300 ppm
Indice de saturation de Langelier	0-1	H <sub>2</sub> S	<0.05 ppm
SO <sub>4</sub> <sup>2-</sup>	<50 ppm	CO <sub>2</sub>	<5 ppm
NH <sub>3</sub>	<1 ppm	Al	<0.2 ppm

Pour des eaux de refroidissement spéciales (désionisée, déminéralisée, distillée) les matériaux standard prévus pour le condenseur pourraient ne pas être appropriés. Dans ce cas, veuillez contacter le constructeur.

### 3.4 Recommandations

Pour ne pas endommager les composants internes du sécheur et du compresseur d'air, éviter des installations où l'air des zones environnantes contient des contaminants : attention donc au soufre, à l'ammoniac, au chlore et aux installations en milieu marin.

Pour les versions avec ventilateurs axiaux, il est déconseillé de canaliser l'air épuisé.

### 3.5 Raccordement électrique

Utiliser un câble homologué aux sens des normes françaises en matière d'électricité et de la réglementation locale (pour la section minimale du câble, voir paragraphe 8.3).

Installer l'interrupteur magnéto-thermique différentiel en amont de l'installation (RCCB-IDn=0.3A) avec une distance d'ouverture des contacts 3mm (voir réglementation locale en vigueur en la matière et s'y conformer). Le courant nominal «In» de ce disjoncteur magnéto-thermique doit être égal à FLA et la courbe de déclenchement de type D.

Sélectionnez l'alimentation et insérez un pont comme indiqué ci-dessous

S7-S6 pour 400/3/50

S8-S6 pour 460/3/60

À l'intérieur du panneau électrique, il y a une étiquette d'instructions.

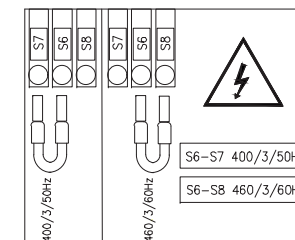

### 3.6 Raccordement purgeur des condensats

☞ Réaliser le raccordement au système de décharge en évitant le raccordement en circuit fermé en commun avec les autres circuits de décharge pressurisés. Contrôler que les systèmes de décharge évacuent régulièrement les condensats. Évacuer tous les condensats conformément à la législation anti-pollution en vigueur.

## 4 Mise en service

### 4.1 Contrôles préliminaires

Avant la mise en service du dessiccateur, vérifier que :

- l'installation a été réalisée conformément aux instructions fournies à la Section 3 ;
- la soupape d'admission d'air est ouverte et aucun écoulement d'air n'est présent dans le dessiccateur ;
- l'alimentation fournie est correcte ;
- en version Wc, ouvrir le circuit d'eau de refroidissement quelques minutes avant de démarrer le dessiccateur.

### 4.2 Démarrage

1. Mettre sous tension en tournant l'interrupteur

général"  " sur "I ON": apparaissent ces informations :

 **LA RESISTANCE CARTER DOIT ETRE BRANCHEE 12 HEURES AVANT LA MISE EN MARCHÉ DU SE-  
CHEUR.**

After, appuyer pour revenir le panneau de commande.

2. appuyer sur  pour démarrer. Le bouton change de couleur, de gris il devient vert, pour in-

diquer que le dessiccateur est maintenant en marche .

3. Démarrer le dessiccateur avant le compresseur d'air.

Le non-respect de cette instruction peut endommager gravement le compresseur.

 Ventilateurs (version Ac) : s'ils sont raccordés dans l'ordre de phases incorrect, ils tourneront dans la direction opposée, avec le risque qu'ils subissent des dégâts (dans ce cas, l'air sort de l'armoire du dessiccateur par les grilles du condenseur plutôt que par les grilles des ventilateurs - pour le débit d'air correct, voir les par. 8.6 et 8.7) ; inverser immédiatement deux phases.

4. Attendre 5 minutes, puis ouvrir lentement la soupape d'admission d'air.
5. Ouvrir lentement la soupape d'échappement d'air : le dessiccateur fonctionne maintenant en mode séchage.

#### Moniteur des phases

Si l'alarme « Moniteur des phases » s'affiche pendant le démarrage du dessiccateur, l'utilisateur doit vérifier le câblage des bornes d'entrée du sectionneur du dessiccateur.

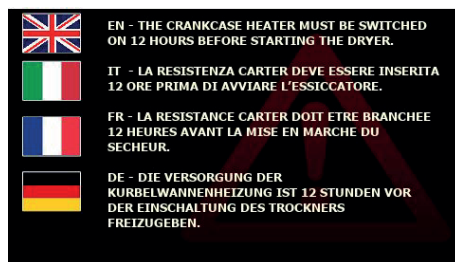



### 4.3 Fonctionnement

- Laisser le dessiccateur en marche tout le temps que le compresseur d'air fonctionne.
- Le dessiccateur travaillant en automatique, les réglages de champ ne sont pas nécessaires.
- En cas de débits d'air excessifs imprévus, les by-passer pour éviter toute surcharge du dessiccateur.
- Éviter les variations de température d'entrée.

### 4.4 Arrêt

1. Arrêter le dessiccateur 2 minutes après l'arrêt du compresseur d'air, ou en tout cas lorsque le débit d'air est interrompu.
2. Vérifier que l'air comprimé ne pénètre pas dans le dessiccateur quand le dessiccateur est débranché ou si une alarme s'est déclenchée.

3. Appuyer sur  pour mettre le dessiccateur hors tension. Le bouton change de couleur et devient gris. 



4. Tourner l'interrupteur général "  " sur « 0 OFF » pour mettre hors tension.

 En version Wc, fermer le circuit d'eau avec le dessiccateur arrêté.



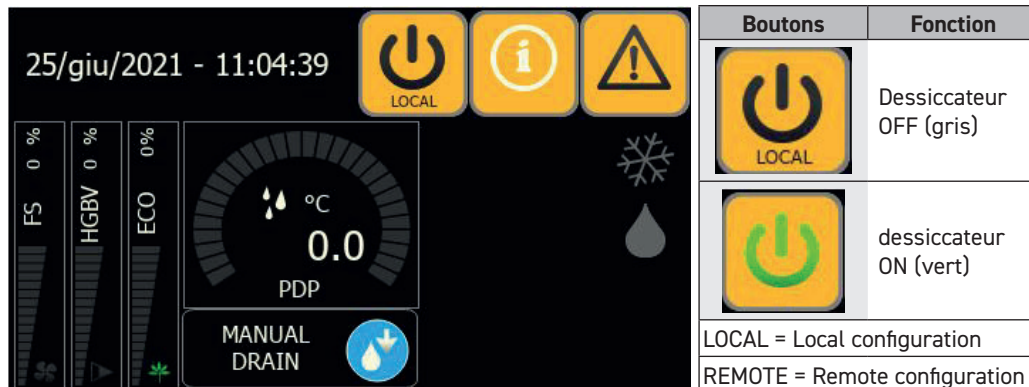

## 5 Commande

### 5.1 Panneau de commande

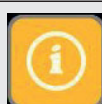

Boutons	Fonction
	Dessiccateur OFF (gris)
	dessiccateur ON (vert)

LOCAL = Local configuration  
REMOTE = Remote configuration

Fonction	Boutons	Fonction
<p><b>FS 48 %</b></p> <p>Vitesse de fonctionnement du ventilateur (uniquement pour la version à condenseur à air)</p>		Accès au menu Information : état de la machine, pressions, températures, paramètres généraux, consommation, mot de passe utilisateur
<p><b>HGBV 14 %</b></p> <p>Vitesse de fonctionnement de la soupape des gaz chauds</p>		Gris = aucune alarme Rouge = avertissement Rouge clignote = alarme
<p><b>ECO 0%</b></p> <p>économie d'énergie.% (Cycle)</p>		Dryer OFF = gris clair Cycling active = vert clignotant Compressor active = bleu clair
		gris = Purgeur de l'eau de condensation OFF vert = Purgeur de l'eau de condensation ON

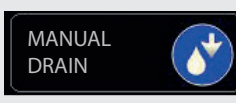
Fonction	Boutons	Fonction
<p><b>8.0</b></p> <p>PDP</p> <p>Appuyer: pour une purge manuelle</p>		Tendance du point de rosée

### 5.2 Menu principal

Appuyer sur  pour ouvrir le menu Information.

Quand un des boutons est enfoncé pendant quelques secondes, le contour s'allume pour confirmer que la sélection a été effectuée.

Ceci vaut pour tous les boutons du panneau de commande.

Appuyer sur  pour revenir les panneau de commandel.

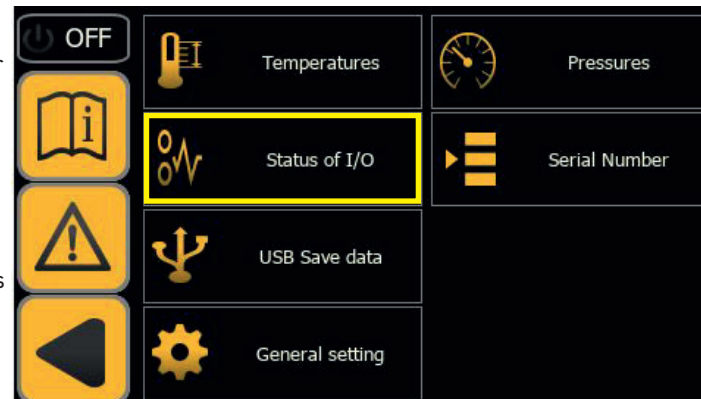

#### 5.2.1 État de la machine (E/S)

Appuyer sur  pour ouvrir le menu État de la machine.

Liste des entrées :  
Une LED à côté de la description indique si les protections / fonctions / configurations sont :  
actives = vert clair  
pas actives = gris clair  
e.g .

Appuyer sur  pour passer à la page suivante.  
Liste des sorties :

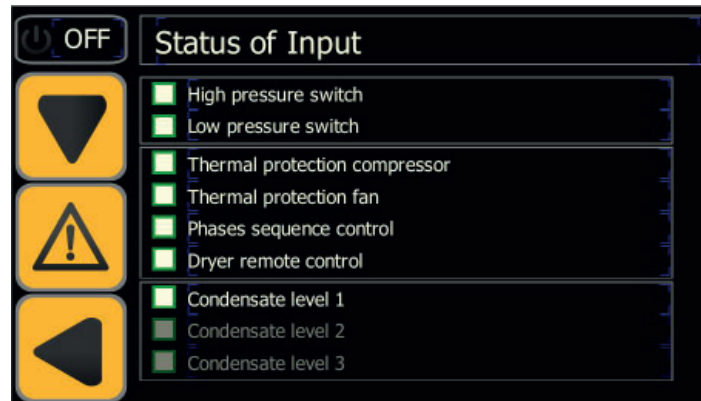

Appuyer sur  pour revenir au menu précédent.

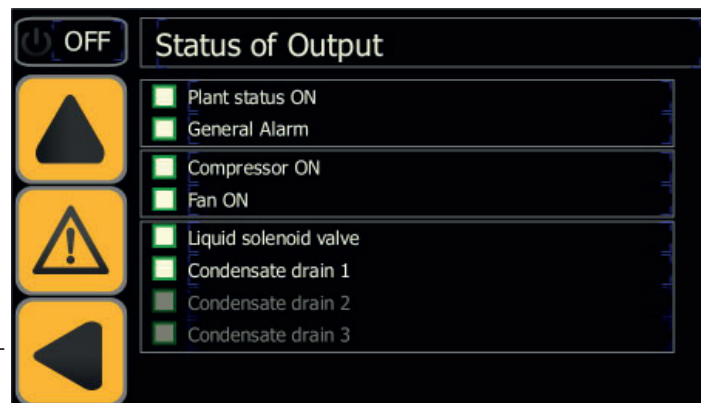

## 5.2.2 Pression

Appuyer sur  pour ouvrir le menu Pression pour visualiser : la pression de condensation, la vitesse de fonctionnement du ventilateur, la pression d'évaporation, la vitesse de fonctionnement de la soupape des gaz chauds.

Appuyez sur un paramètre spécifique pour afficher la tendance des données de ses performances au fil du temps.

p.ex. Pression de condensation/d'évaporation

Utiliser  et  pour faire défiler le graphique.

Appuyer sur  pour revenir au menu précédent.

p.ex. Vitesse de fonctionnement de la soupape des gaz chauds/du ventilateur

Utiliser  et  pour faire défiler le graphique.

Appuyer sur  pour revenir au menu précédent.

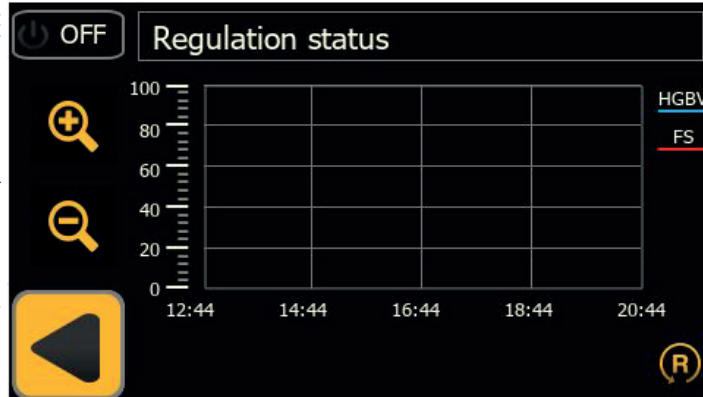
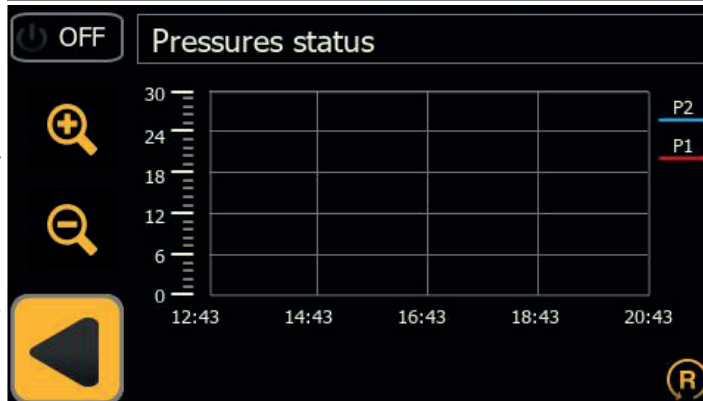
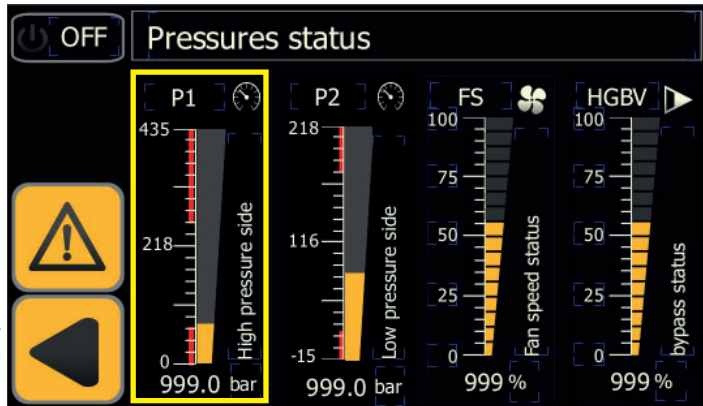

## 5.2.3 Température

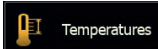
Appuyer sur  pour afficher les températures relevées par les capteurs de température du schéma du circuit.

Appuyer sur  pour passer à la page suivante.

B4 = actif uniquement pour la version multicooler.

Appuyez sur l'une des valeurs de température basse pression pour voir une tendance des données de toutes les sondes du circuit basse pression.

Appuyez sur l'une des valeurs de température haute pression pour voir une tendance des données de toutes les sondes du circuit haute pression.

Température - Basse pression circuit

Utiliser  et  pour faire défiler le graphique.

Appuyer sur  pour revenir au menu précédent.

Température - Haute pression circuit

Utiliser  et  pour faire défiler le graphique.

Appuyer sur  pour revenir au menu précédent.

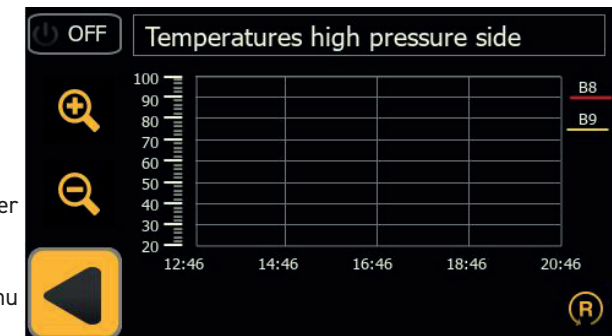
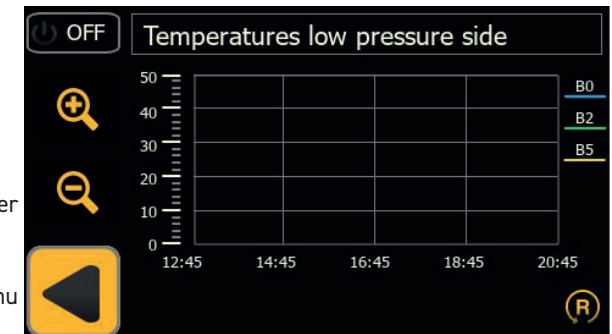
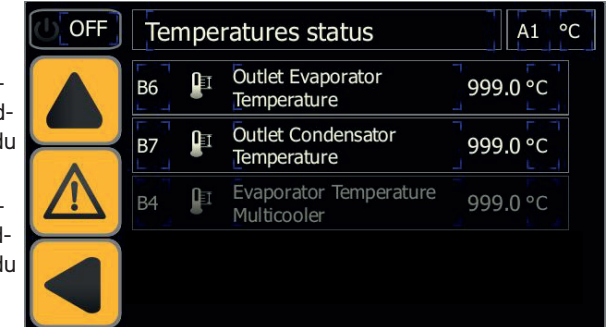
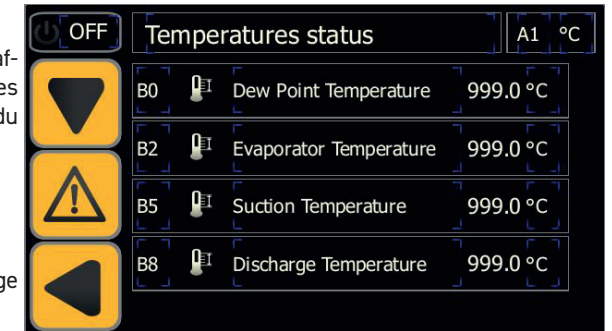

## 5.2.4 Général

Appuyer sur  pour ouvrir le menu Général qui propose les sections suivantes : langue ; date/heure ; paramètre ; maintenance ; cycle/fonctionnement continu. Appuyer un menu pour afficher / régler.

Appuyer sur  pour revenir les panneau de commande.

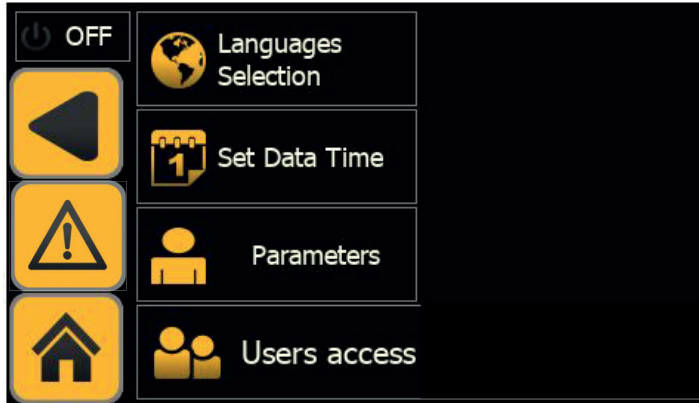

### 5.2.4.1 Langue

Appuyer sur  pour ouvrir le menu Langue. Appuyer sur la langue souhaitée. Le système revient automatiquement au menu principal dans la langue choisie.

Appuyer sur  pour revenir au menu précédent.

Appuyer sur la langue souhaitée. Le système revient automatiquement au menu principal dans la langue choisie.

Appuyer sur  pour revenir au menu précédent.





## 5.2.4.2 Date/Temps

Appuyer sur  pour ouvrir le menu Date/temps.

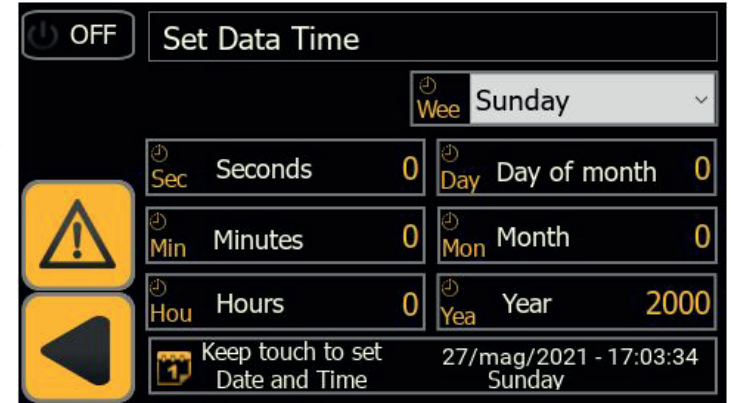
Appuyer sur Date/Temps pour effectuer la modification.



Appuyez pendant 2 secondes  pour confirmer.

Appuyer sur  pour revenir au menu précédent.

### 5.2.4.3 Menu User

Appuyer sur  pour ouvrir le menu "User". Ce menu est réservé aux techniciens de service Parker.

User name:

Password:

Show password

### 5.2.4.4 Paramètre

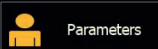
Appuyer sur  Paramètres pour ouvrir le menu Paramètre qui propose les sections suivantes : capteurs, purgeur, configuration de l'eau de condensation, maintenance, cycle. Appuyer sur le bouton pour ouvrir le menu.

Appuyer sur  pour revenir au menu précédent.

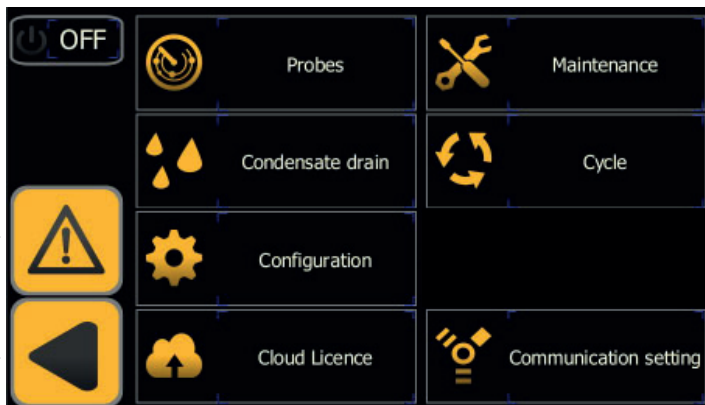

### Capteurs

Appuyer sur  Probes pour paramétrer les avertissements et les retards ou le point de rosée minimum/maximum.

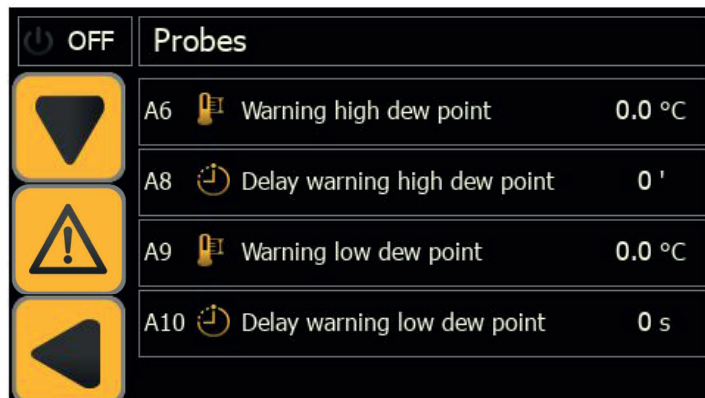

### Purgeur de l'eau de condensation

Appuyer sur  Condensate drain pour ouvrir le menu Purgeur de l'eau de condensation. pour fixer:

1. Purgeur temporisé (avec choix des heures de fermeture et d'ouverture) ;
2. Purgeur capacitif ;
3. Purgeur continu (purgeur externe).

Appuyer sur  pour revenir au menu précédent.

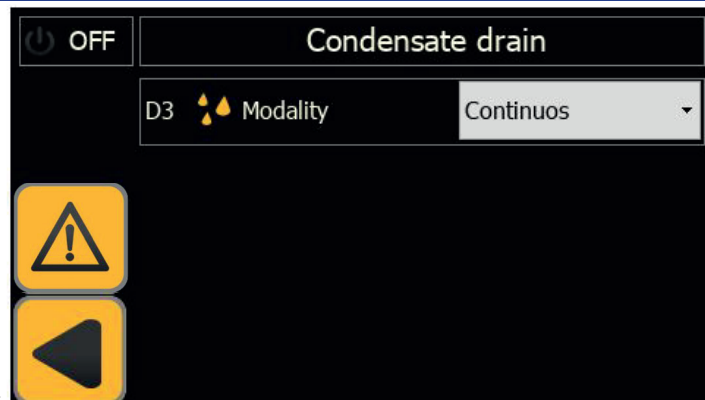

### Configuration

Appuyer sur  Configuration pour ouvrir l'écran de configuration avec le menu suivant :

1. Choix de l'affichage de température en °C / °F ;
2. Activation du démarrage à distance ;
3. Activation des alarmes uniquement ou des alarmes / avertissements ;
4. Rétablissement des paramètres par défaut.

Utiliser le bouton pour fermer la description et faire son choix.

 Pour gérer le mode REMOTE OFF, retirer le pont entre les bornes : 87-92 et brancher l'interrupteur marche/arrêt à distance (à prévoir par le client).

### Maintenance

Appuyer sur  Maintenance pour afficher les heures de fonctionnement du compresseur/dessiccateur.

Appuyer sur  pour revenir au menu précédent.

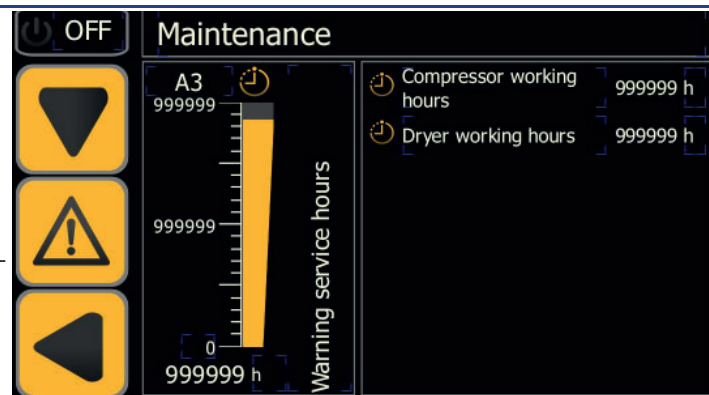
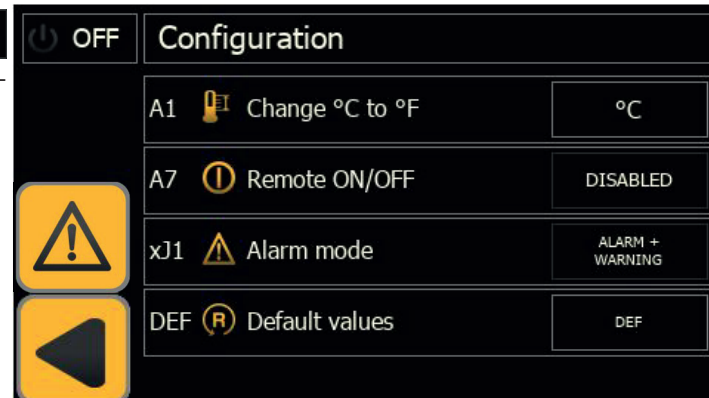

## Fonctionnement

Appuyer sur  Cycle pour choisir le type de fonctionnement : continu ; cycle (économie d'énergie).

Touchez le paramètre pour effectuer le réglage.

Appuyer sur  pour revenir au menu précédent.

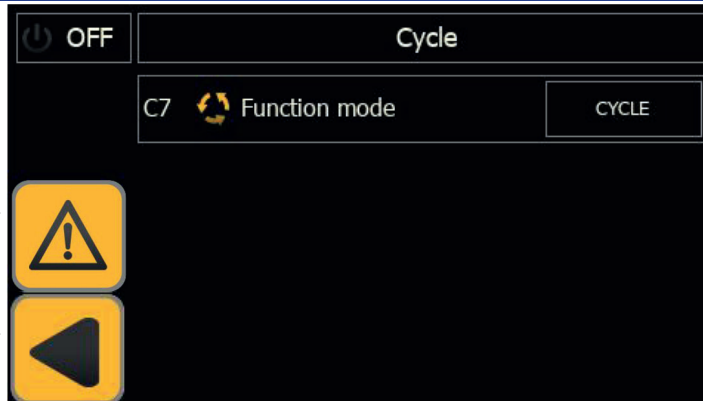

## Modbus

Appuyer sur  Communication setting pour régler les paramètres Modbus.  
MODBUS RTU (RS485)

Appuyer sur  pour passer à la page suivante.

MODBUS TCP/IP

Appuyer sur  pour revenir au menu précédent.

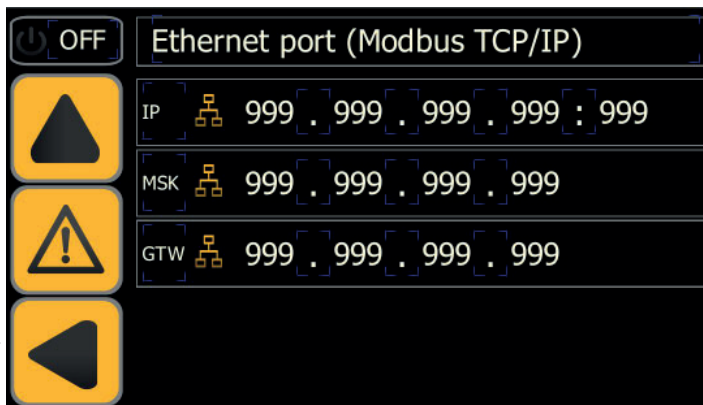
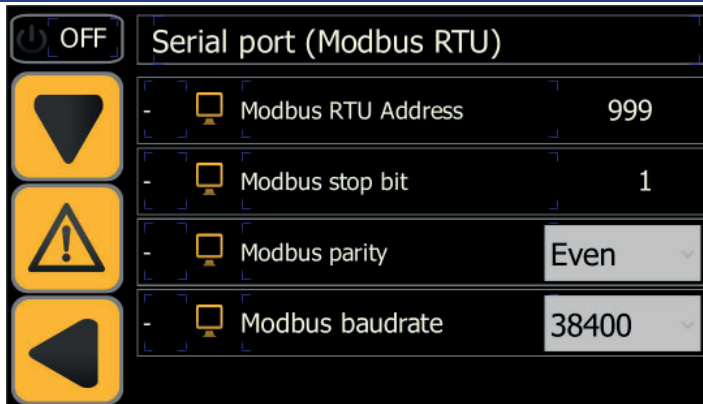

Éteignez/Allumez le dessiccateur pour confirmer la configuration.

## Cloud

Appuyer sur  Cloud Licence pour voir « password » pour le cloud.

Cette option est en cours.

Appuyer sur  pour revenir au menu précédent.

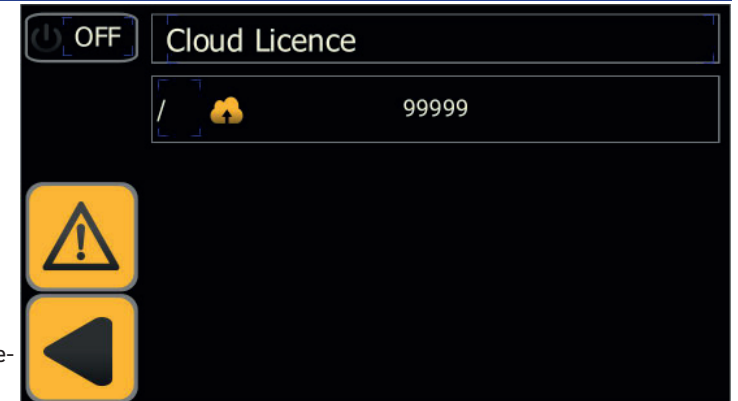

### 5.2.5 Date du numéro de série

Appuyer sur  Serial Number pour ouvrir le menu «serial number».

Appuyer sur  pour revenir les panneau de commande.

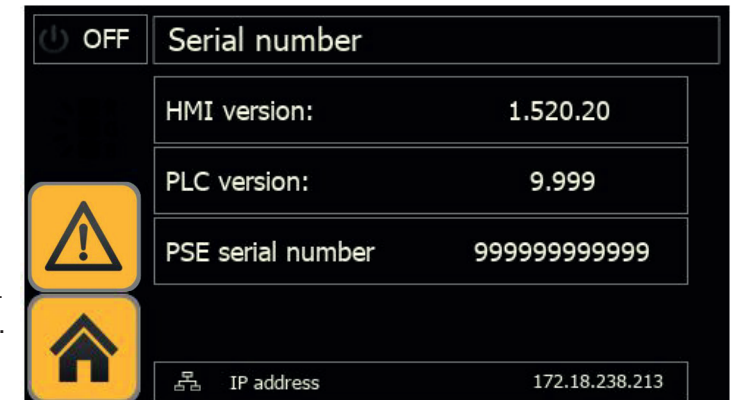

### 5.2.6 Télécharger

Insérez la clé USB and appuyer sur  Touch to save the trends pour télécharger les graphiques des températures et des pressions.  
Utilisez une clé USB avec led, qui vous montre la phase de téléchargement.

Appuyer sur  pour revenir au menu précédent.

## 5.3 Alarmes/Avertissements

Appuyer sur  pour ouvrir le menu Alarmes/Avertissements.

Touchez « durée » pour modifier l'heure de la recherche.

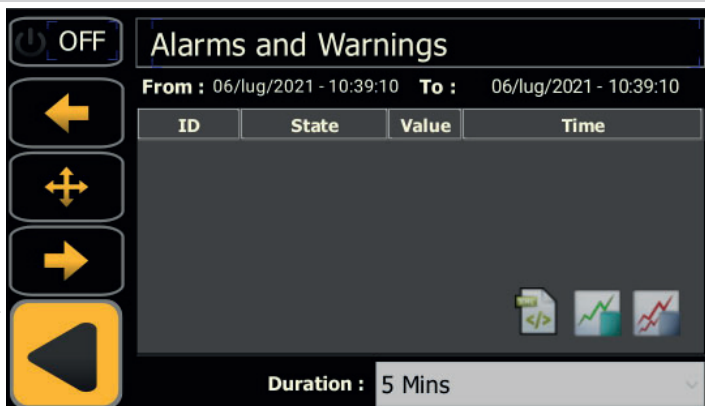



Après le rétablissement des conditions de fonctionnement nominales, certains avertissements et certaines alarmes sont réinitialisés automatiquement. D'autres doivent être réinitialisés manuellement.

Appuyer sur  pour réinitialiser l'alarme.

Appuyer sur  pour afficher l'historique des alarmes avec les informations suivantes :

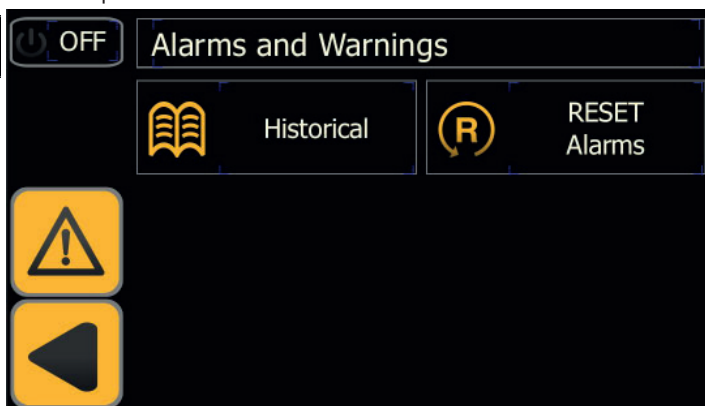
code alarme, date, nombre d'alarmes, position dans l'ordre d'occurrence et date/heure d'activation des alarmes.



Appuyer sur  pour revenir au menu précédent.

### 5.3.1 Liste des alarmes/avertissement

a = alarme; w = avertissement

Code	Alarme/Avertissement	Cause
aLD	alarme Bas point de rosée	température B0<A9 pour plus de A10 seconds.
aLT	alarme basse température d'évaporation.	température B2<A12 pour plus de A13 seconds
aHT2	alarme de température de refoulement élevée	température B8>A11
aHP	alarme haute pression	pressostat haute pression activé
aLP	alarme basse pression	pressostat basse pression activé
aLTA	alarme basse température multicooter	température B4<A12 pour plus de A13 seconds
aPI*	alarme Protection thermique compresseur.	protection thermique compresseurn activé
aPH	alarme moniteur de phase	moniteur de phase activé (pour 460-750)
aCM1	alarme communication expansion 1	l'expansion 1 ne communique pas
aCM2	alarme communication expansion 2	l'expansion 2 ne communique pas
wB0	avertissement sonde B0	sonde cassée ou non connectée
wB2	avertissement sonde B2	sonde cassée ou non connectée
wB4	avertissement sonde B4	sonde cassée ou non connectée
wB5	avertissement sonde B5	sonde cassée ou non connectée
wB6	avertissement sonde B6	sonde cassée ou non connectée
wB8	avertissement sonde B8	sonde cassée ou non connectée
aFP1	alarme haute pression transmetteur P1	transmetteur cassée ou non connectée
wHD	avertissement haute point de rosée	température B0>A6 pour plus de A8 minutes
wHT1	avertissement de température de refoulement élevée	température B8>A14 pour plus de A15 minutes
wHP1	avertissement haute pression	pression P1>A16 pour plus de 2 seconds
wHB5	avertissement de température d'aspiration élevée	température B5>A18 pour plus de 1 minute
wLP2	avertissement basse pression	pression P2<A21 pour plus de 150 seconds
wSR	avertissement Entretien programmé	le temps de service défini a expiré
wDR1	avertissement purgeur de condensats 1	le condensat ne s'écoule pas du sécheur 1
wDR2	avertissement purgeur de condensats 2	le condensat ne s'écoule pas du sécheur 2
wDR3	avertissement purgeur de condensats 3	le condensat ne s'écoule pas du sécheur 3
aFP2	alarme basse pression transmetteur P2	transmetteur cassée ou non connectée

\* pour les modèles de 900 à 1800, l'alarme peut également avoir la signification de phases inversées.



## 5.4 Menu Rapide

Ouvrir le menu en quelques étapes :

### Afficher la température

Appuyer sur  → Appuyer sur  Appuyer sur la température pour afficher les graphiques

### Afficher la pression

Appuyer sur  → Appuyer sur  Appuyer sur la pression pour afficher les graphiques.

### Télécharger

Appuyer sur  → Appuyer sur  pour télécharger.



### Date du numéro de série

Appuyer sur  → Appuyer sur  .

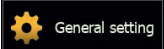

### Modifier la langue

Appuyer sur  → Appuyer sur  → Appuyer sur  Choisir la langue.

### Date/Temps

Appuyer sur  → Appuyer sur  → Appuyer sur  Mettre à jour l'horloge.

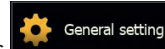
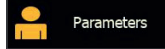
### Modifier l'unité de mesure °C en °F, Remote, DEF



Appuyer sur  → Appuyer sur  → Appuyer sur  → Appuyer sur  :

Appuyer sur le paramètre °C ou °F pour effectuer la modification.

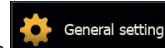

Activer / désactiver le paramètre **"Remote ON/OFF"** .

Touchez **"DEF"** pour restaurer le paramètre

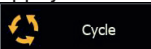

### Passer en mode Cycle

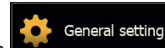
Appuyer sur  → Appuyer sur  → Appuyer sur  → Appuyer sur  change the operation.

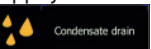
### Purgeur

Appuyer sur  → Appuyer sur  → Appuyer sur  → Appuyer sur  Choisir le purgeur.

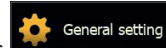
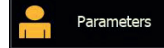

## Modbus

Appuyer sur  → Appuyer sur  → Appuyer sur  → Appuyer sur 

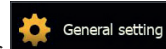
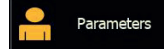
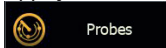
### Réglage du paramètre

Appuyer sur  → Appuyer sur  → Appuyer sur  → Appuyer sur  modifier le paramètre.

### Alarme / Avertissement

Appuyer sur  → Appuyer sur  pour trouver l'alarme historique et réinitialiser l'alarme.

Appuyer sur  pour afficher l'historique.

Appuyer sur  pour réinitialiser l'alarme.

## 6 Entretien

• La machine est conçue et fabriquée pour garantir un fonctionnement continu ; toutefois, la durée de vie de ses composants est directement liée à l'entretien effectué.

-  Pour toute demande d'assistance ou de pièces détachées, identifier la machine en communiquant le modèle et le numéro de série figurant sur la plaque signalétique apposée à l'extérieur de l'appareil.

### 6.1 Recommandations générales

 Avant toute opération d'entretien, s'assurer que :

- le circuit d'air comprimé n'est plus sous pression ;
- que le sécheur soit débranché du réseau d'alimentation électrique.

 En cas de fuite du réfrigérant, appeler un professionnel qualifié et agréé par le constructeur.

 Utiliser toujours des pièces de rechange d'origine ; dans le cas contraire, le constructeur est dégage de toute responsabilité pour le mauvais fonctionnement de la machine

 La vanne ou valve Schrader ne doit être utilisée qu'en cas d'anomalie de fonctionnement de la machine : dans le cas contraire, les dommages causés par une charge de réfrigérant incorrecte ne seront pas reconnus au titre de la garantie.

### 6.2 Réfrigérant

Opération de charge : les dommages éventuels causés par une charge incorrecte de réfrigérant effectuée















par un personnel non habilité ne seront pas reconnus au titre de la garantie. 

 L'appareil contient des gaz à effet de serre fluorés.

Le fluide frigorigène R513A à température et pression normales est un gaz incolore appartenant au SAFETY GROUP A1 - EN378 (fluide groupe 2 selon la directive PED 97/23/EC); GWP (Global Warming Potential) = 573.

## 6.3 Programme d'entretien préventif

Pour une efficacité et une fiabilité maximales durables du sécheur, effectuer :



Descrição das actividadesde manutenção	Intervalo de manutenção (em condições de funcionamento padrão)				
	Todos os dias	Todas as semanas	A cada 4 meses	Anualmente	A cada 36 meses
<b>Actividade</b> verificar  assistência 					
Contrôler que le témoin POWER ON est allumé					
Contrôler les indicateurs du tableau des commandes.					
Nettoyer le filtre de la vanne pressostatique à eau s'il n'est pas sale augmenter l'intervalle de contrôle (voir notice) (PSE750-1800)					
Contrôler le purgeur des condensats.					
Nettoyer les ailettes du condenseur					
Contrôler le positionnement correct de la résistance carter.					
Contrôler la consommation électrique.					
Contrôler les fuites de réfrigérant.					
Dépressurisation de l'installation. Effectuer l'entretien du purgeur.					
Dépressurisation de l'installation. Remplacer les éléments du préfiltre et du post-filtre.					
Contrôler les sondes de température. Remplacer si nécessaire.				 	
Kit d'entretien séchoir.					

Sont disponibles (voir paragraphe 8.4) :

- Kits d'entretien préventif 3 ans ;
- Kits d'entretien
  - kits compresseur ;
  - kits ventilateur ;
  - Kits soupape à gaz chaud;
  - Kits condenseur d'eau ;
- pièces détachées.

## 6.4 Mise au rebut

Le fluide frigorigène et le lubrifiant (huile) contenus dans le circuit devront être récupérés selon la législation antipollution.

 Recyclage	Recyclage Élimination 
charpenterie (ossature)	acier/résines époxy-polyester
échangeur	aluminium
tuyauteries/collecteurs	cuivre/aluminium/acier au carbone
purgeur	polyamide
isolation échangeur	EPS (polystyrène fritté)
isolation tuyauteries	caoutchouc synthétique
compresseur	acier/cuivre/aluminium/huile
condenseur	cuivre/aluminium
réfrigérant	R513A
valves ou vannes	laiton
câbles électriques	cuivre/PVC

Les équipements contenant des composants électriques doivent être éliminés séparément avec les déchets électriques et électroniques conformément à la législation locale et en vigueur.



# 7 Dépannage

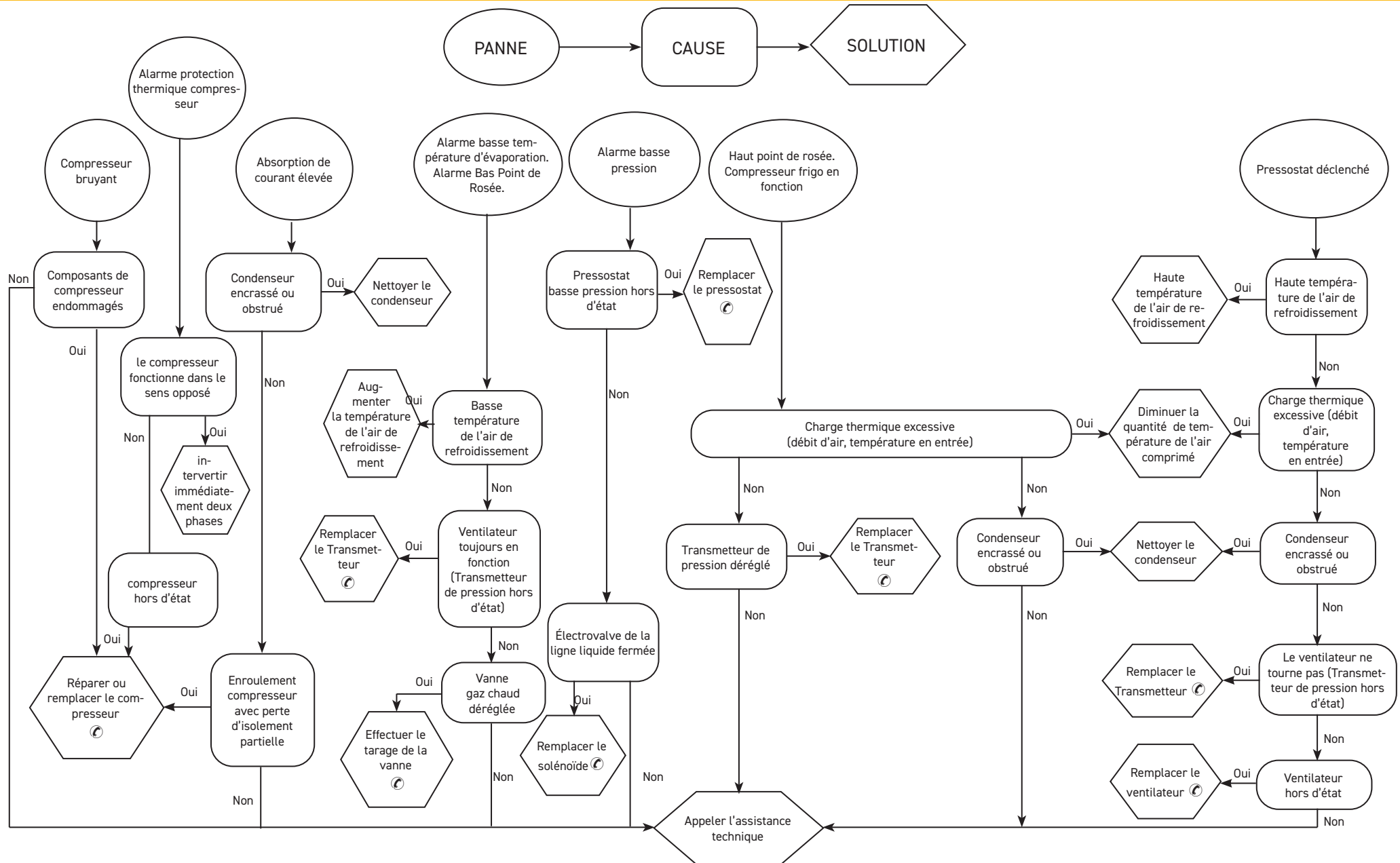

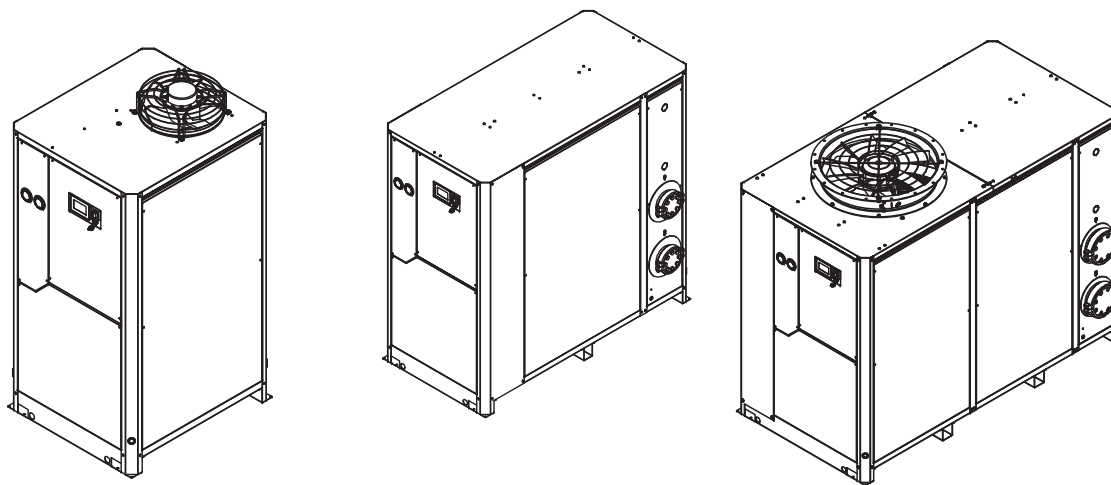

### CONTENTS

8.1 LEGEND	2
8.2 INSTALLATION DIAGRAM	4
8.3 TECHNICAL DATA	5
8.4 SPARE PARTS	6
8.5 EXPLODED DRAWING	8
8.6 DIMENSIONAL DRAWING	14
8.7 REFRIGERANT CIRCUIT	20
8.8 WIRING DIAGRAM PSE 1400-2000	26
WIRING DIAGRAM PSE 2400-6000	41

## 8.1 LEGEND

Symbol	/EN/ES/FR
	Weight / Peso/ Poids /
	/ Ambient temperature / Temperatura ambiente / Température Ambiente
	/ During transport and stockage / Durante transporte y almacenaje / Pendant le transport et le stockage
	/ After installation / Después de la instalación / Après l'installation
	/ Air-side max. working pressure / Presión máxima de trabajo lado aire / Pression maximum d'utilisation côté air
	/ Compressed air inlet temperature / Temperatura entrada aire comprimido / Température entrée air comprimé
	/ Minimum cable size for electrical connection. / Sección mínima cable homologado para conexionado Eléctrico / Section minimale câble homologué pour le raccordement électrique.
	/ Compressed air inlet / Entrada aire comprimido / Entrée air comprimé
	/ Compressed air outlet / Salida aire comprimido / Sortie air comprimé
	/ Cooling water inlet / Entrada agua de enfriamiento / Entrée eau de refroidissement
	/ Cooling water outlet / Salida agua de enfriamiento / Sortie eau de refroidissement
	/ Calibration values / Valores de calibración / Valeurs de réglage
	/ Electrical supply inlet / Entrada alimentación eléctrica / Entrée alimentation électrique
	/ Condensate drain / Drenaje de condensados / Purge des condensats
	/ Limit of equipment / Límite del equipo / Limite de l'appareil

Symbol	/EN/ES/FR
	/ Sound pressure level (1m distance in free field - according to ISO 3746). / Nivel de presión sonora (a 1 m de distancia en campo libre, según norma ISO 3746) / Niveau de pression sonore à 1 mètre de distance en champ libre (selon norme ISO 3746)
	/ Cooling air outlet / Salida aire de enfriamiento / Sortie air de refroidissement
	/ Cooling air inlet / Entrada aire de enfriamiento / Entrée air de refroidissement
	/ General alarm / Alarma general / Alarme générale
	/ Optional / Opcional / Option
	/ Compressor / Compresor / Compresseur
	/ Refrigerant condenser / Condensador refrigerante / Condenseur réfrigérant
	/ Shell & tube exchanger
	/ Fan motor / Electroventilador / Électroventilateur
	/ Refrigerant filter / Filtro refrigerante / Filtre réfrigérant
	/ Liquid line solenoid valve / Electroválvula línea de líquido / Électrovanne ligne de liquide
	/ Expansion capillary / Capillar expansión / Tubo de détente
	/ Evaporator / Evaporador / Évaporateur
	/ Low pressure transmitter
	/ Pressure point / Toma de presión / Prise de pression
	/ Pressure gauge
	/ Low pressure switch / Presostato baja presión / Pressostat basse pression
	/ Electronic hot gas valve / Válvula gas caliente / Vanne gas valve
	/ High pressure switch / Presostato alta presión / Pressostat haute pression
	/ High pressure transmitter
	/ Condensate drain valve / Grifo drenaje condensados / Robinet décharge condensats

Symbol	/EN/ES/FR
	/ Condensate filter valve / Filtro drenaje condensados / Filtre décharge condensats
	/ Condensate drain solenoid valve / Electroválvula drenaje condensados / Électrovanne décharge condensats / Škidruma separators
	/ Water pressostatic valve / Válvula presostática agua / Valve presostatique eau
<b>WPV</b>	
-	/ Panels / Paneles / Panneaux
<b>A1</b>	/ Control Card / Tarjeta electrónica / Carte électronique
<b>A2</b>	/ Serial card / Tarjeta serie / Carte série
<b>AI</b>	/ Analog Inputs / Entradas analógicas / Entrées analogiques
<b>B0</b>	/ Dew point temperature sensor / Sensor temperatura punto rocío / Capteur de température dew point
<b>B2</b>	/ Evaporation temperature sensor / Sensor temperatura evaporación / Capteur de température évaporation
<b>B3</b>	/ Ambient temperature sensor
<b>B5</b>	/ Suction temperature sensor
<b>B8</b>	/ Discharge temperature sensor / Sensor temperatura salida refrigerante / Capteur de température départ réfrigérant
<b>CS1</b>	/ Condensate level sensor / Sensor de nivel / Capteur de niveau
<b>EH1</b>	/ Crankcase heater / Resistencia cárter / Résistance carter
<b>FA1</b>	/ Control card fuse / Fusible tarjeta electrónica / Fusible carte électronique
<b>FU1-4</b> <b>FU11</b>	/ Fuses / Fusibles / Fusibles
<b>DI</b>	/ Digital Inputs / Entradas digitales / Entrées numériques
<b>KA1</b>	/ High pressure alarm relay / Relé alarma presostato alta presión / Relais alarme pressostat haute pression
<b>KM1</b>	/ Compressor contactor / Contactor compresor / Contacteur compresseur
<b>KM2</b>	/ Fan contactor / Contactor ventilador / Contacteur ventilateur
<b>QF1</b>	/ automatic switch / Interruptor automático / Interrupt. automatique
<b>QS1</b>	/ Main power switch / Interruptor general / Interrupteur général
<b>RO</b>	/ Remote Off / Apagado remoto / Def remoto

## 8.1 LEGEND

Symbol	/EN/ES/FR
SL	/ Serial line / Línea serie / Liaison série
TC1	/ Auxiliary transformer / Transformador auxiliares / Transformateur auxiliaires
DO	/ Digital Outputs / Salidas digitales / Sorties numériques
X1-X5	/ Terminal blocks / Borneras / Boîtes à bornes
(#)	Components for models with TIMED drain. For other external drains, consult the constructor's manual. Componentes presentes en el modelo con sistema de drenaje TEMPORIZADO. Para los dispositivos de drenaje externos, consulte el manual de fábrica respectivo. Composants présents dans les modèles avec purgeur temporisé. Pour d'autres purgeurs externes, consulter la notice spécifique du constructeur.

## 8.2 INSTALLATION DIAGRAM

1	2	3	4
Air compressor Compresor de aire Compresseur d'air	Dryer Secador Sécheur	By-pass unit Grupo by-pass Groupe by-pass	Filter [3 micron filtration or better] near dryer air inlet Filtro (filtración de 3 micrones o mejor) cerca de la entrada de aire de la secadora Filtre (filtration des particules de 3 microns minimum) à proximité de l'orifice d'admission d'air du sécheur

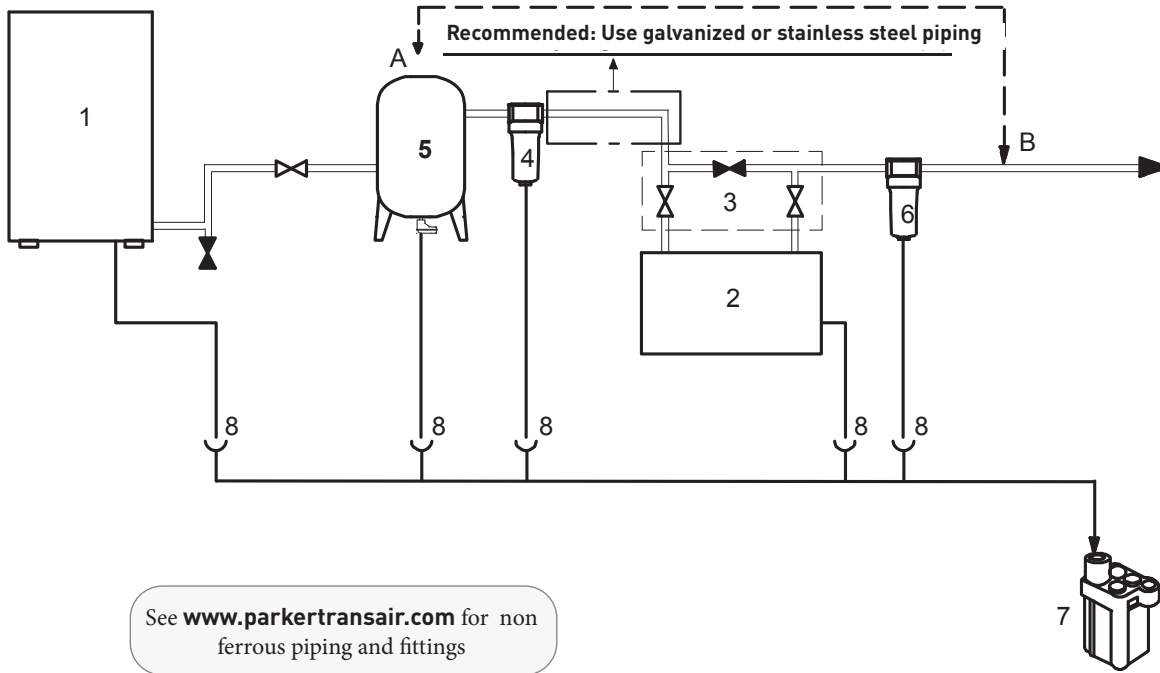

Safety relief valves should not exceed dryer design pressure  
Válvulas de seguridad para no superar la presión de diseño del secador  
Soupapes de sécurité, pour ne pas dépasser la pression préétablie du sécheur









Use flexible hoses for air connections if the compressed air system is subject to vibration.  
Tubos flexibles para las conexiones de aire si la red está expuesta a vibraciones  
Tuyaux flexibles pour raccordements de l'air si le réseau est soumis à des vibrations



5	6	7	8
Tank in position A or in B Depósito en la posición A o B Réservoir en position A ou B	Outlet filter Filtro de salida Filtre en sortie	Oil-Water separator Separador agua-aceite Séparateur eau-huile	Condensate drain Drenaje de condensados Purgeur des condensats

Use pulsation dampers if compressed air system is subject to pulsation  
Amortiguadores si la red está expuesta a pulsaciones  
Amortisseurs hydrauliques appropriés si le réseau est soumis à des pulsations



### 8.3 TECHNICAL DATA

Model	Weight 	Refrigerant R513A				N° of coolers	MIN.- MAX Ambient Temperature 		Compressed air inlet Temperature 	F.L.A.[A] 575V±10% /3Ph/60Hz	MOP	MCA	Connections			Sound pressure level 
		Ac		Wc			During transport and storage 	After installation 					Compres. air IN/OUT 	Cooling Water IN/OUT 	Conden. drain 	
		Kg	CO <sub>2</sub> e(t)	Kg S&T	CO <sub>2</sub> e(t) S&T											
PSE 1400	380	2.7	1.55	3.8	2.19	1	32-122°F (0-50°C)	41-122°F (5-50°C)	41-149°F (5-65°C)	14.2	30	17.5	4" FLG ANSI 150	1"	1/2"	58
PSE 1600	420	2.0	1.15	3.2	1.83	1				20.6	40	25.5				
PSE 2000	730	7.6	4.35	7.0	4.0	2				31.6	65	40	6" FLG ANSI 150	1.1/4"		69
PSE 2400	770	8.0	4.60	8.5	4.87	2				37.8	80	47				
PSE 3000	-	-	-	-/-	-/-	2							52.3	110		65
PSE 3800	850	6.0	3.44	6.0	3.44	2				59.4	125	74				
PSE 5000	1070	15	8.61	12.3	7.0	3							59.4	125		74
PSE 6000	1210	13.0	7.45	11.0	6.3	3										

Calibration values 	Hot gas valve 12 - HGV	Pressure condensation		High pressure Switch 13-HP	Low pressure Switch 10-LP	Operating Pressure Max 	Water pressostatic valve 3-WPV	IP	Safety valve
		Pressure	Fan speed						
PSE 1400-5000	35-38 psi 2.4-2.6 bar	145-188psi 10-13 bar	0 % 100 %	290psi 20 bar	14.5-29psi 1.0-2.0 bar	174psi 12 bar	232psi 16 bar	54	-
PSE 6000									320psi 22 bar

## 8.4 SPARE PARTS

COMPONENTS		See par. 8.5	PSE 1400	PSE 1600	PSE 2000	PSE 2400	PSE3000	PSE 3800	PSE 5000	PSE 6000	
3 years preventive maintenance kits	Ac/ Wc	⑧ ⑪ ⑬ ⑮ B0 B2 B8	398H473757								
Electrical Kit	Ac/Wc		398H473759								
Compressor kit	Ac/Wc	① ④ KM1	398H473766	398H473768	398H473769	398H473770			398H473771	398H473772	
Fan kit	Ac	③	398H473774		398H473775			398H473776			
Hot gas valve kit	Ac/Wc	④ ⑫	398H473779	398H473780	398H473781			398H473782			
Refrigerant condenser	Ac	②	ET-398H114845		ET-398H114846			ET-398H114847			
Shell & tube exchanger	Wc	②.2	ET-398H186234	ET-398H186235	ET-398H186236	ET-398H186237			ET-398H186193		
Water pressostatic valve	Wc	③.	ET-398H378209		ET-398H378204				Et-398H378220		
Refrigerant filter	Ac/Wc	④	398H206223	398H206224							
Liquid line solenoid valve	Ac/Wc	⑤	ET-398H183148								
Water - air exchanger / Separator / Air-air exchanger	Ac/Wc	⑦	398H473479CRN	398H473480CRN	398H473479CRN	398H473480CRN	398H473479CRN	398H473480CRN	398H473480CRN	398H473480CRN	
Low Pressure transmitter	Ac	⑧	ET-398H275315								
Pressure gauge	Ac	⑩ ⑭	ET-398H354042								
Low pressure switch	Ac/Wc	⑪	ET-398H474521								
High pressure switch	Ac	⑬	ET-398H474520						ET-398H474523		
High Pressure transmitter	Ac	⑮	ET-398H275311								
Water pressostatic valve	Wc S&T	⑳	398H378202		398H378203	398H378204	398H378204	398H378204	398H378204	398H378220	
Safety Valve kit	Ac/Wc	⑳	-		-			398H473783			

## 8.4 SPARE PARTS

COMPONENTS		See par. 8.5	PSE 1400	PSE 1600	PSE 2000	PSE 2400	PSE3000	PSE 3800	PSE 5000	PSE 6000	
Electronic card touch AVC6200	Ac/Wc	A1	398H473785								
Expansion EVE6000	Ac/Wc	-	398H473786								
Display touch	Ac	-	398H473788								
	Wc	-	398H473788Y001								
Hot gas valve control	Ac/Wc	-	398H473789								
Dew point/ evaporator temperature sensor	Ac/Wc	B0	398H275894								
Evaporation temperature sensor	Ac/Wc	B2	398H275894								
Ambient temperature sensor	Ac/Wc	B3	398H275894								
Suction temperature sensor	Ac/Wc	B5	398H275894								
Discharge temperature sensor	Ac/Wc	B8	ET-398H275973								
Condensate level sensor	Ac/Wc	CS3/4/5	398H275752								
Phases monitor	Ac/Wc	A4	398H256366				-				
Main disconnect switch	Ac/Wc	QS1	398H256424								
Compressor Automatic switch	Ac/Wc	QF1	398H256294		398H256363		ET-398H256201		ET-398H256200		
Compressor contactor	Ac/Wc	KM1	398H256246		398H256325		398H256296		ET-398H256251		
Fan contactor	Ac	KM2	398H256243								
Auxiliary transformer	Ac/Wc	TC1	ET-398H255854								
Condensate drain solenoid valve	Ac/Wc	16-17-18	398H698218								

# 8.5 EXPLODED DRAWING PSE1400-1600 Ac

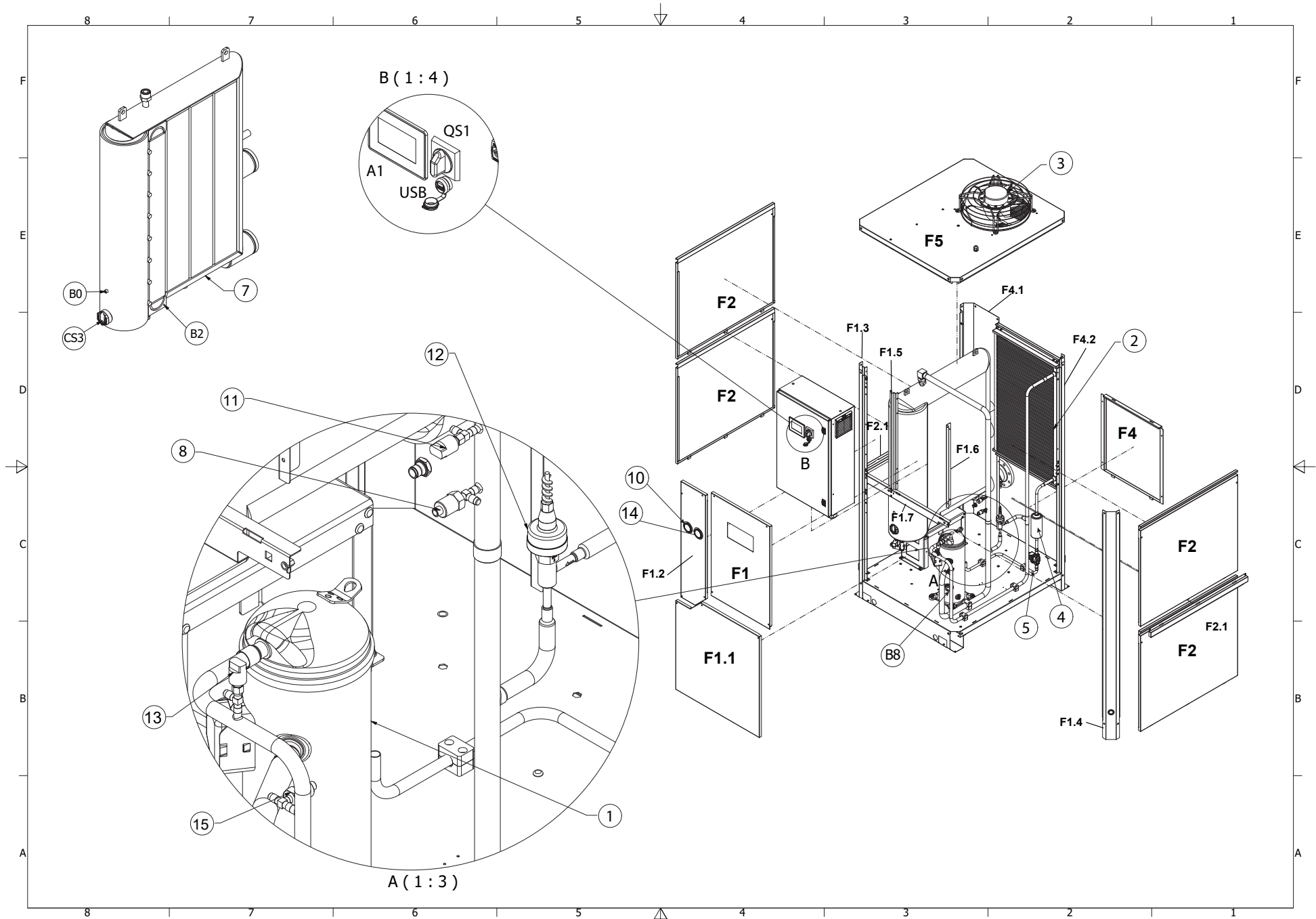

# 8.5 EXPLODED DRAWING PSE 2000-3800 Ac

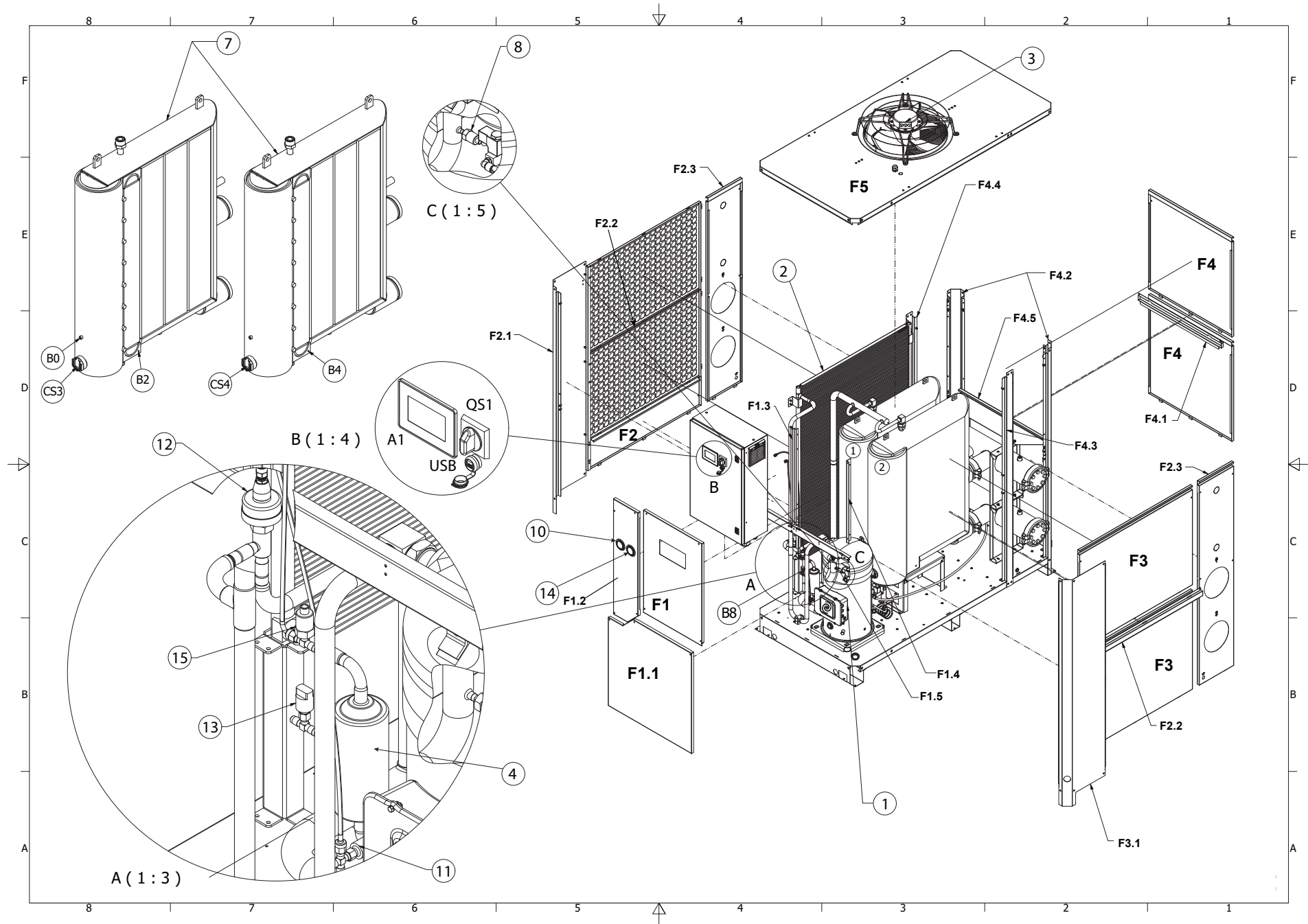

# 8.5 EXPLODED DRAWING PSE 5000-6000 Ac

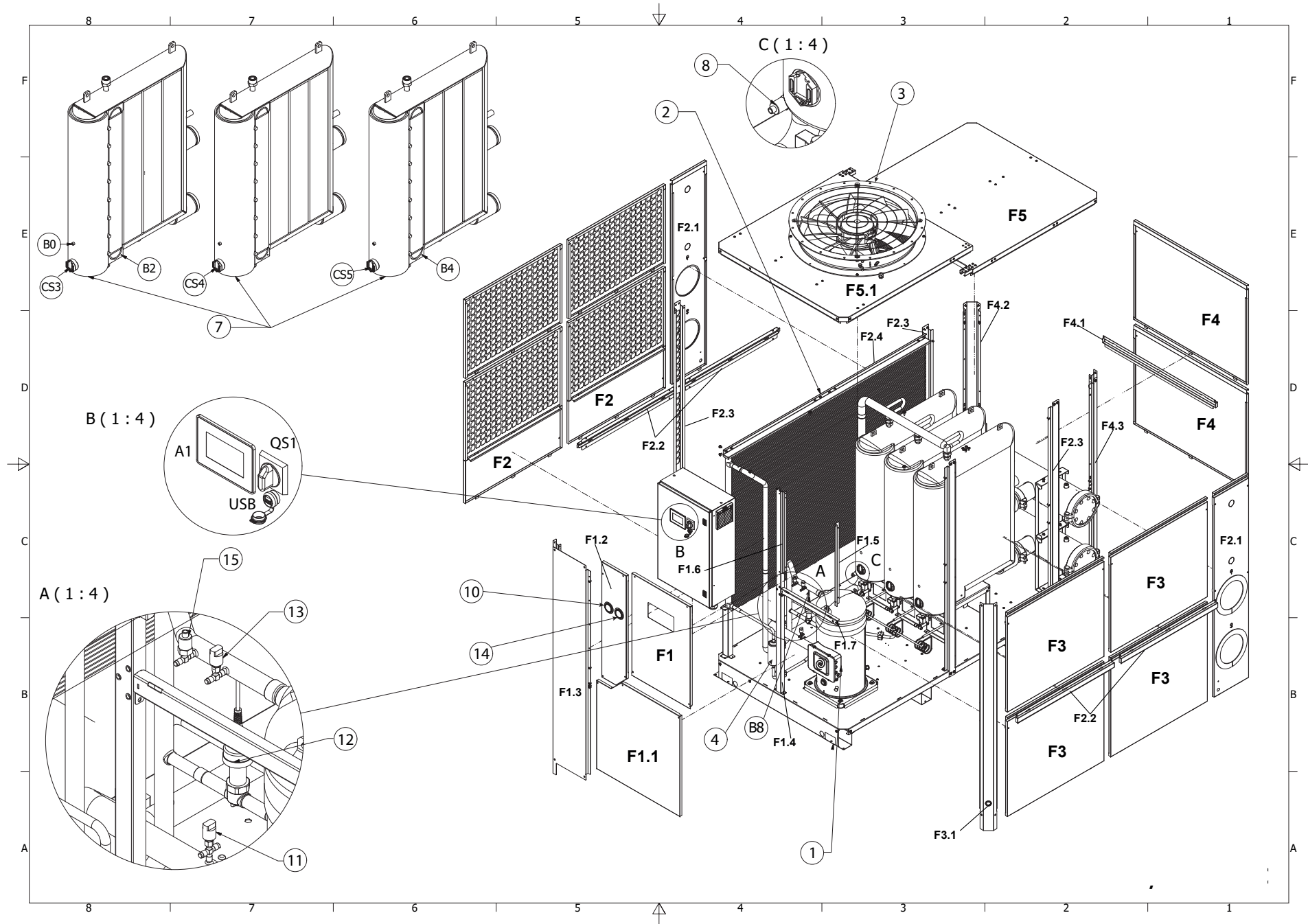

# 8.5 EXPLODED DRAWING PSE 1400-1600 Wc

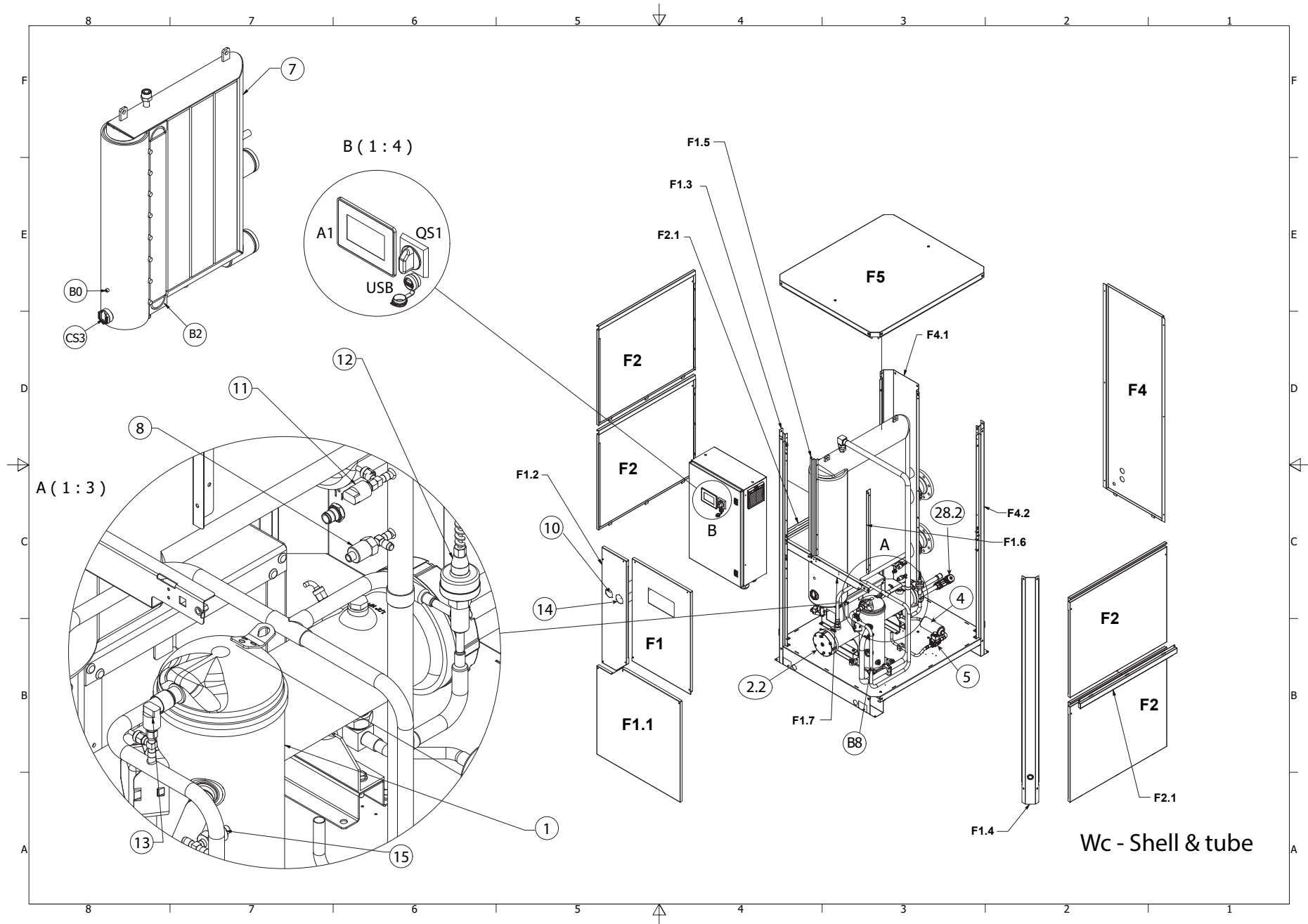

# 8.5 EXPLODED DRAWING PSE 2000-3800 Wc

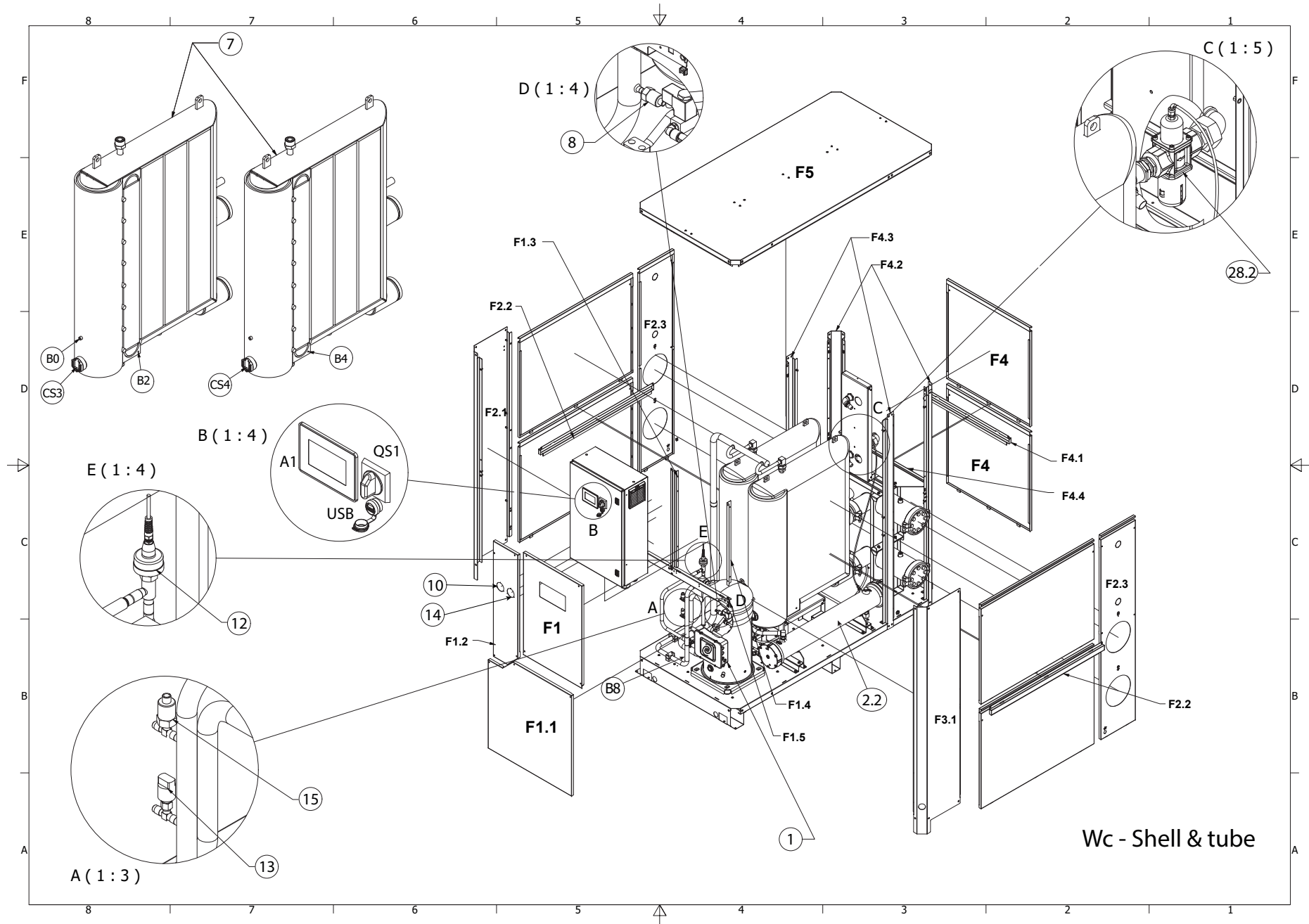

Wc - Shell & tube



# 8.5 EXPLODED DRAWING PSE 5000-6000

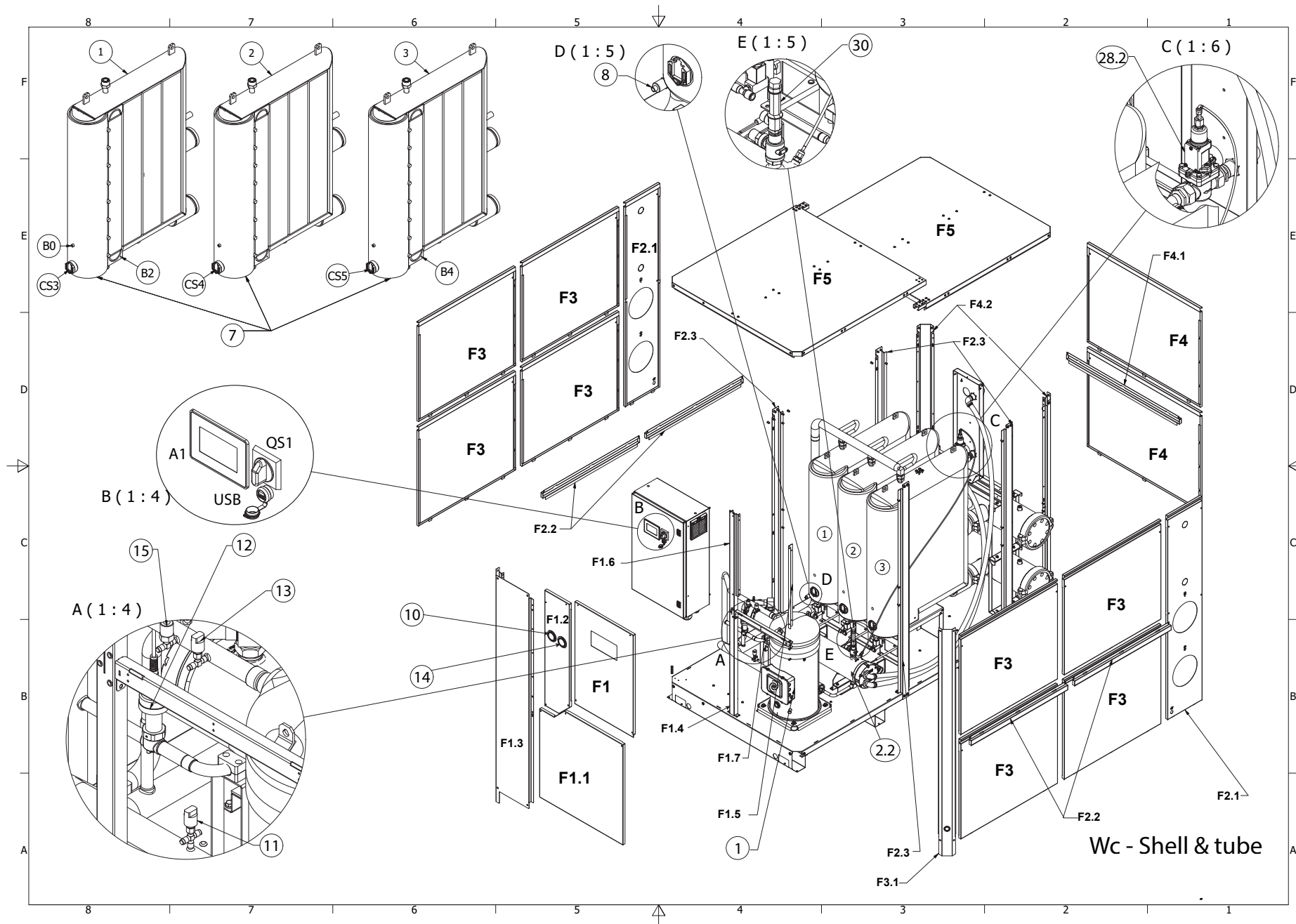

# 8.6 DIMENSIONAL DRAWING PSE 1400-1600 Ac

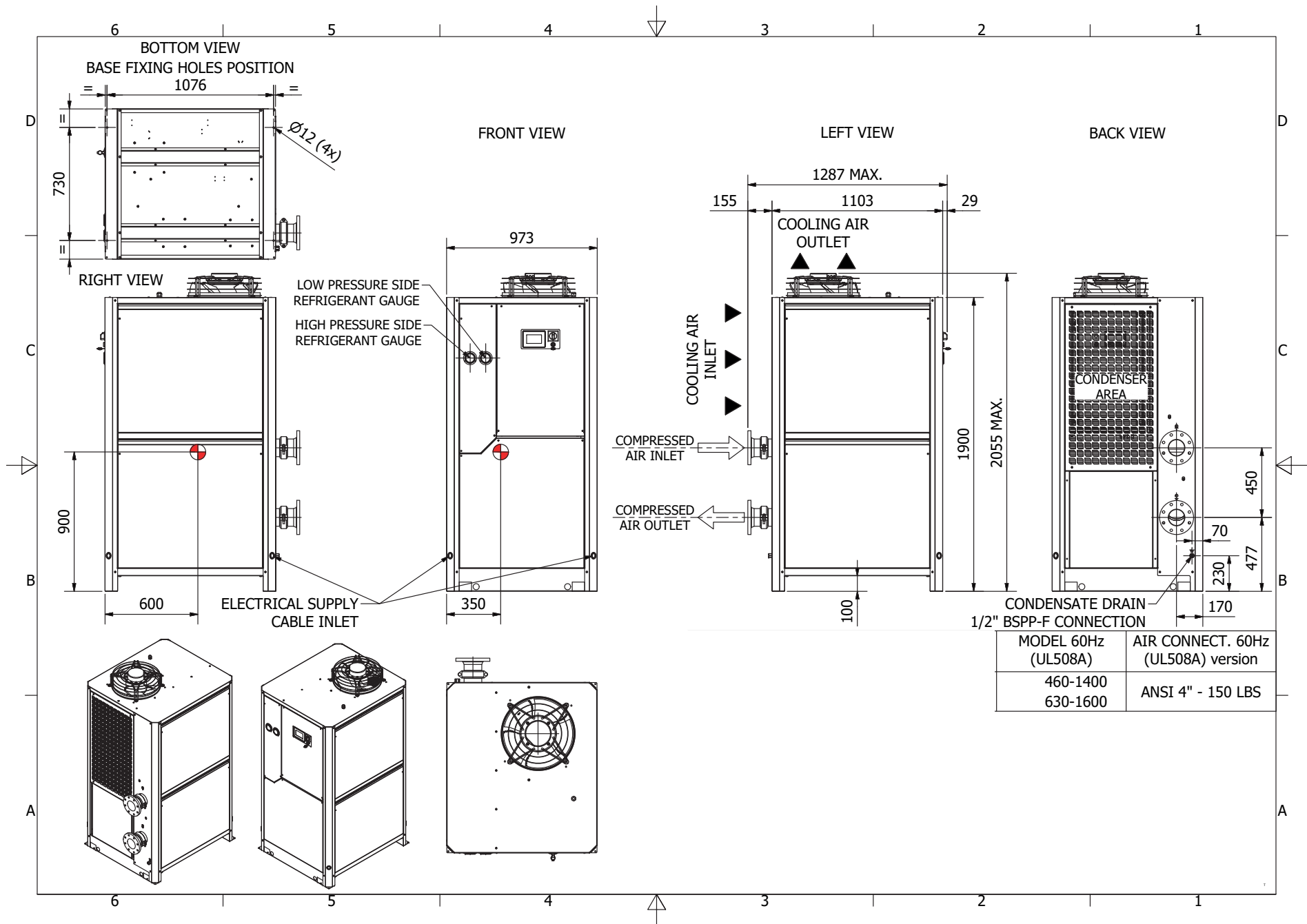

# 8.6 DIMENSIONAL DRAWING PSE 2000-3800 Ac

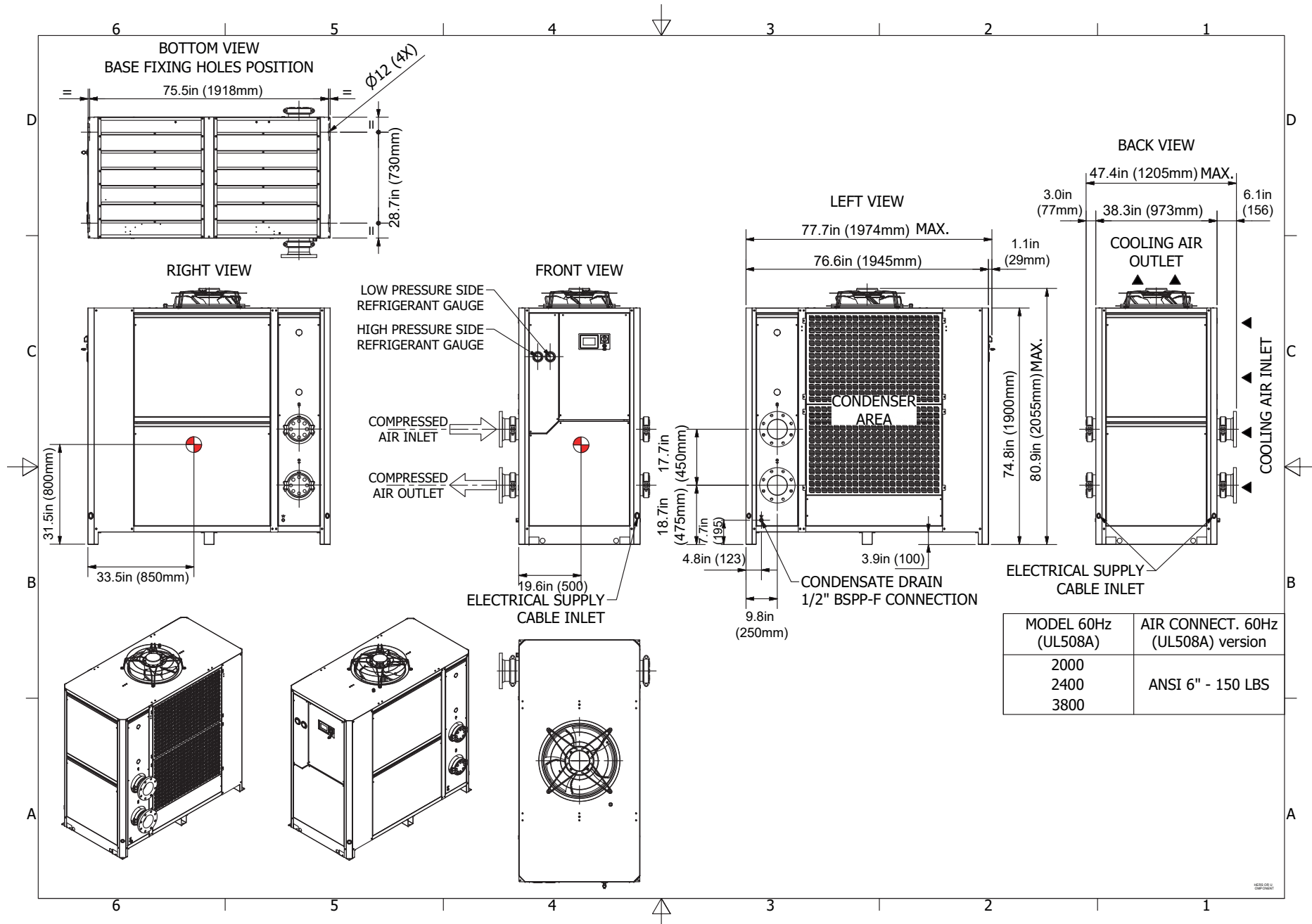

# 8.6 DIMENSIONAL DRAWING PSE 5000-6000 Ac

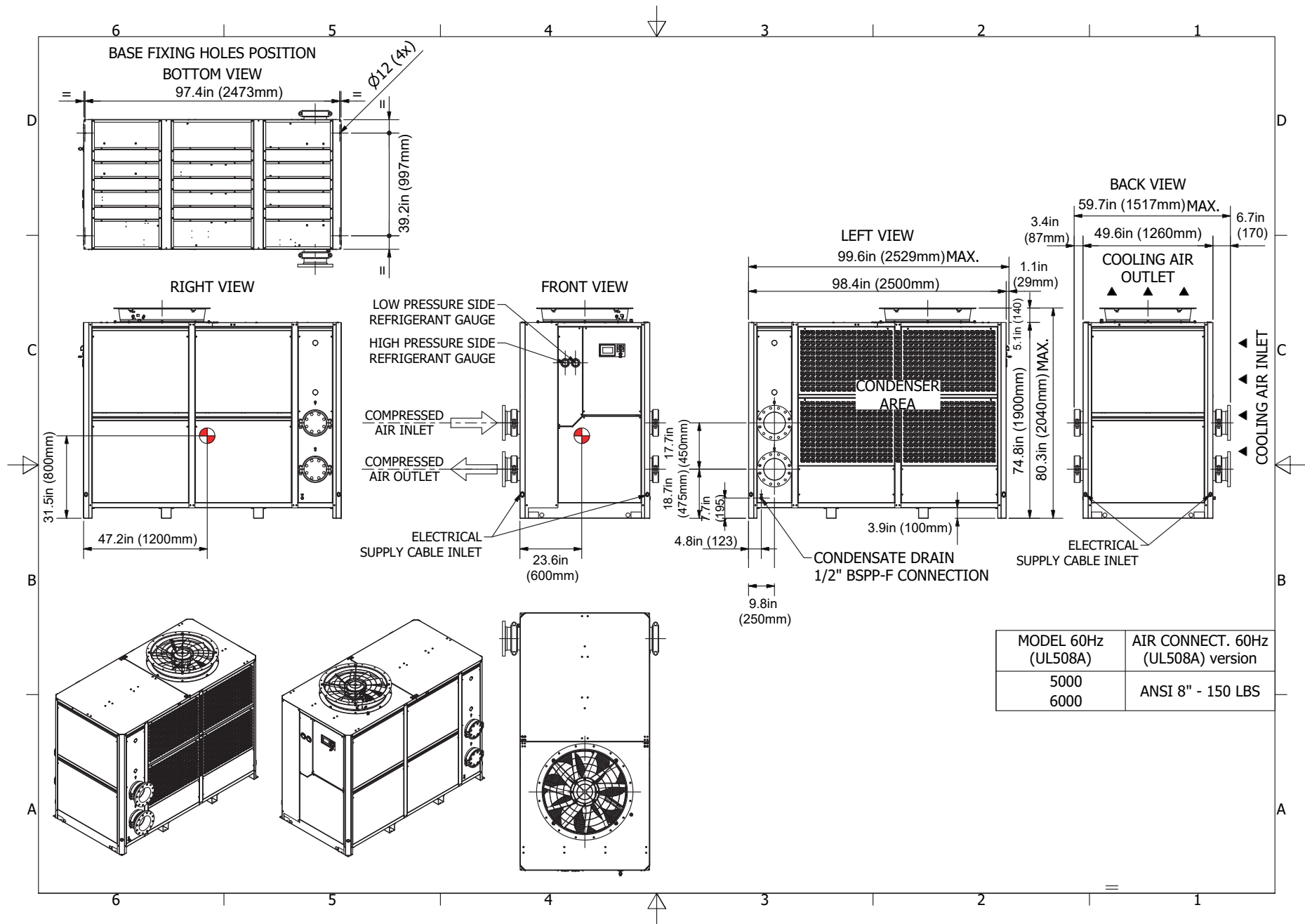

# 8.6 DIMENSIONAL DRAWING PSE 1400-1600 Wc

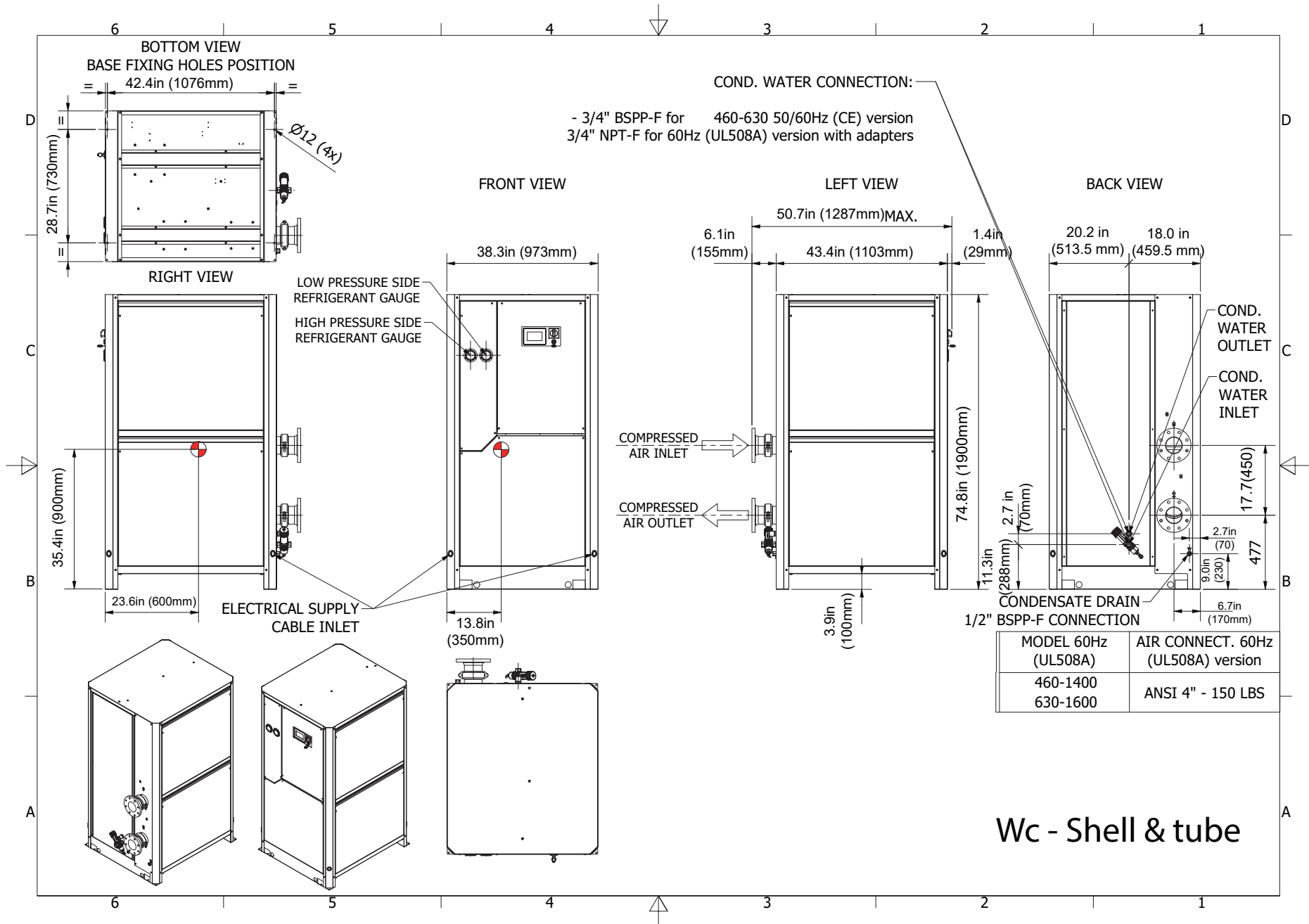

# 8.6 DIMENSIONAL DRAWING PSE 2000-3800 Wc

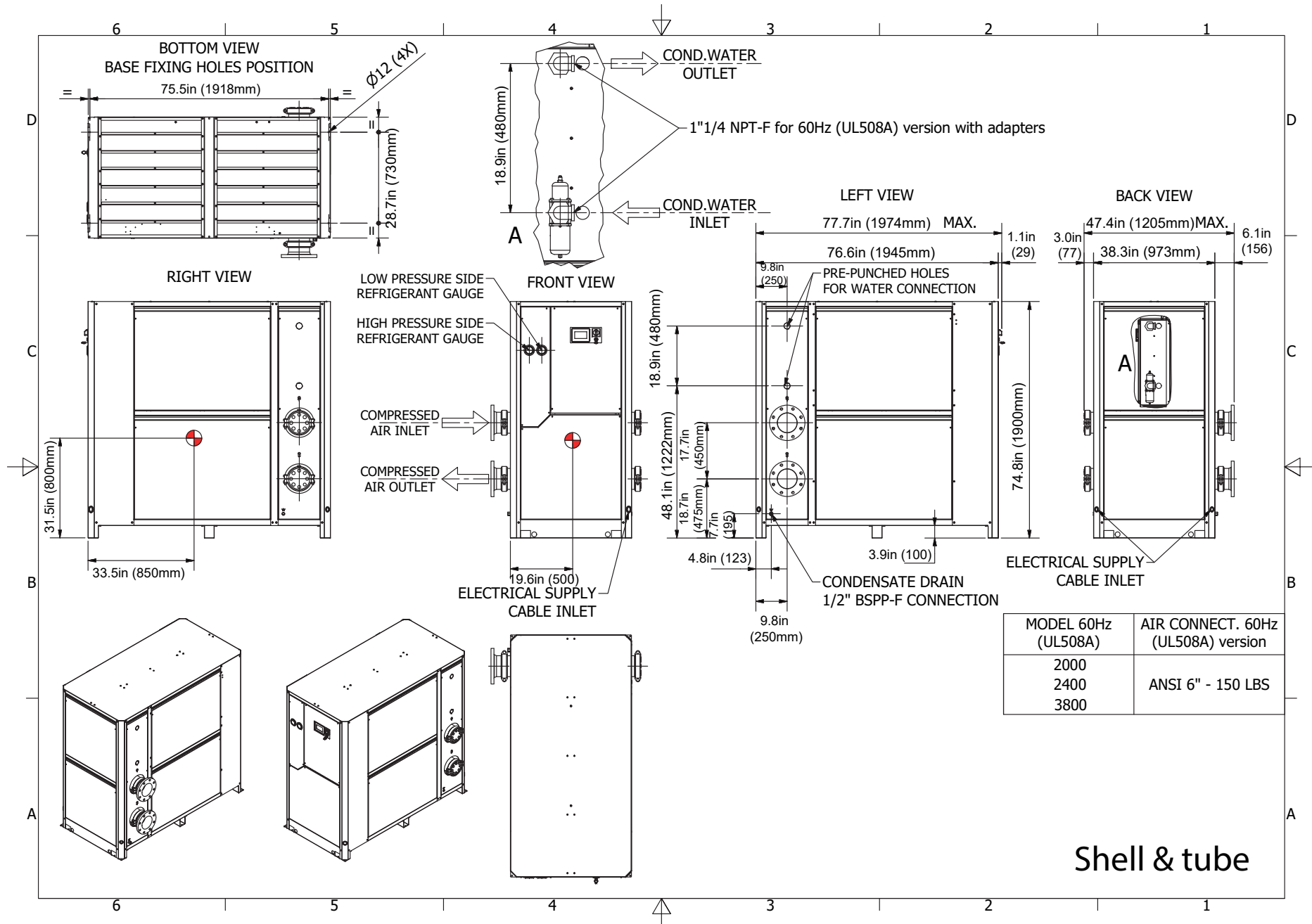

# 8.6 DIMENSIONAL DRAWING PSE 5000-6000 Wc

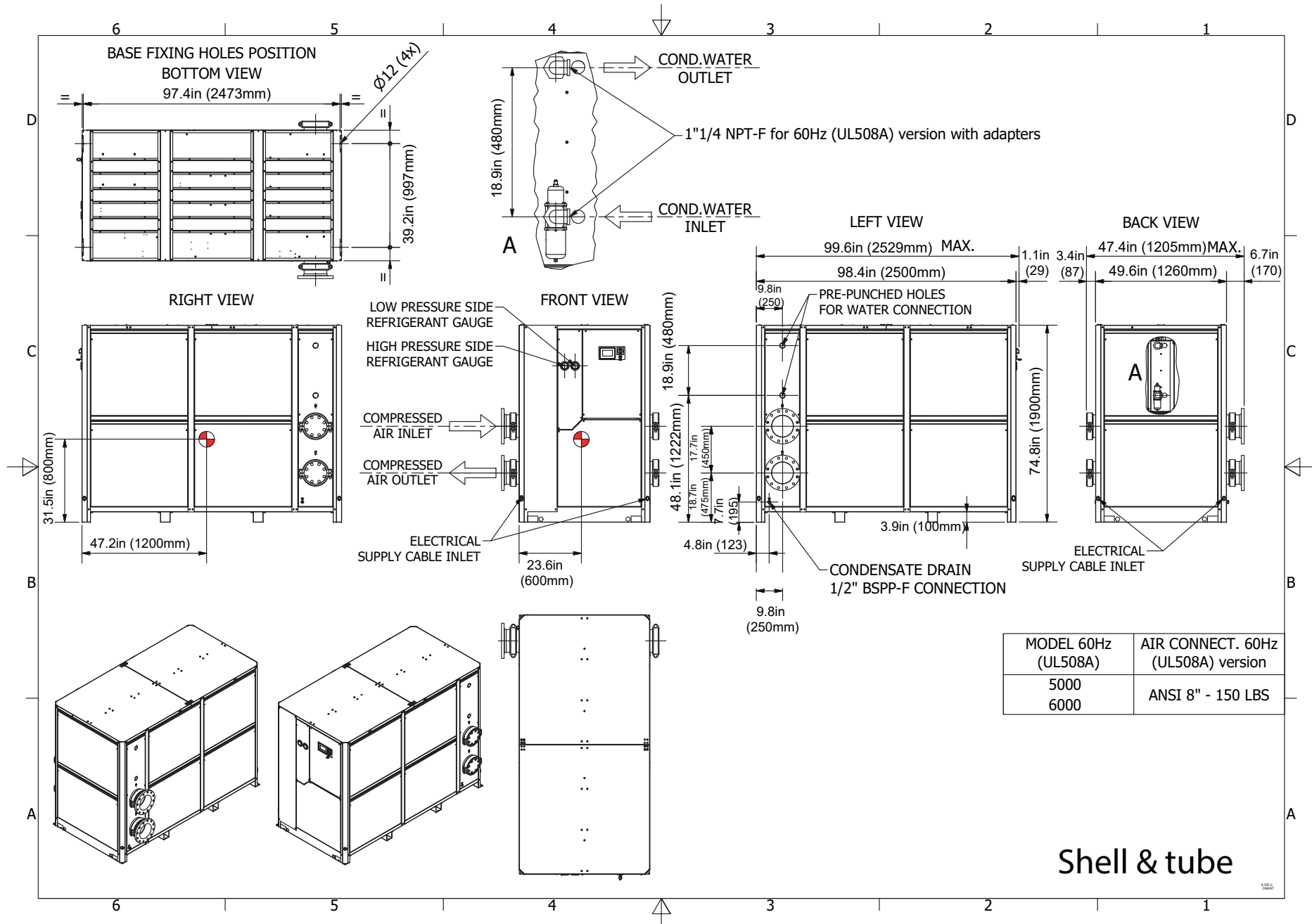

## 8.7 REFRIGERANT CIRCUIT PSE 1400-1600 Ac

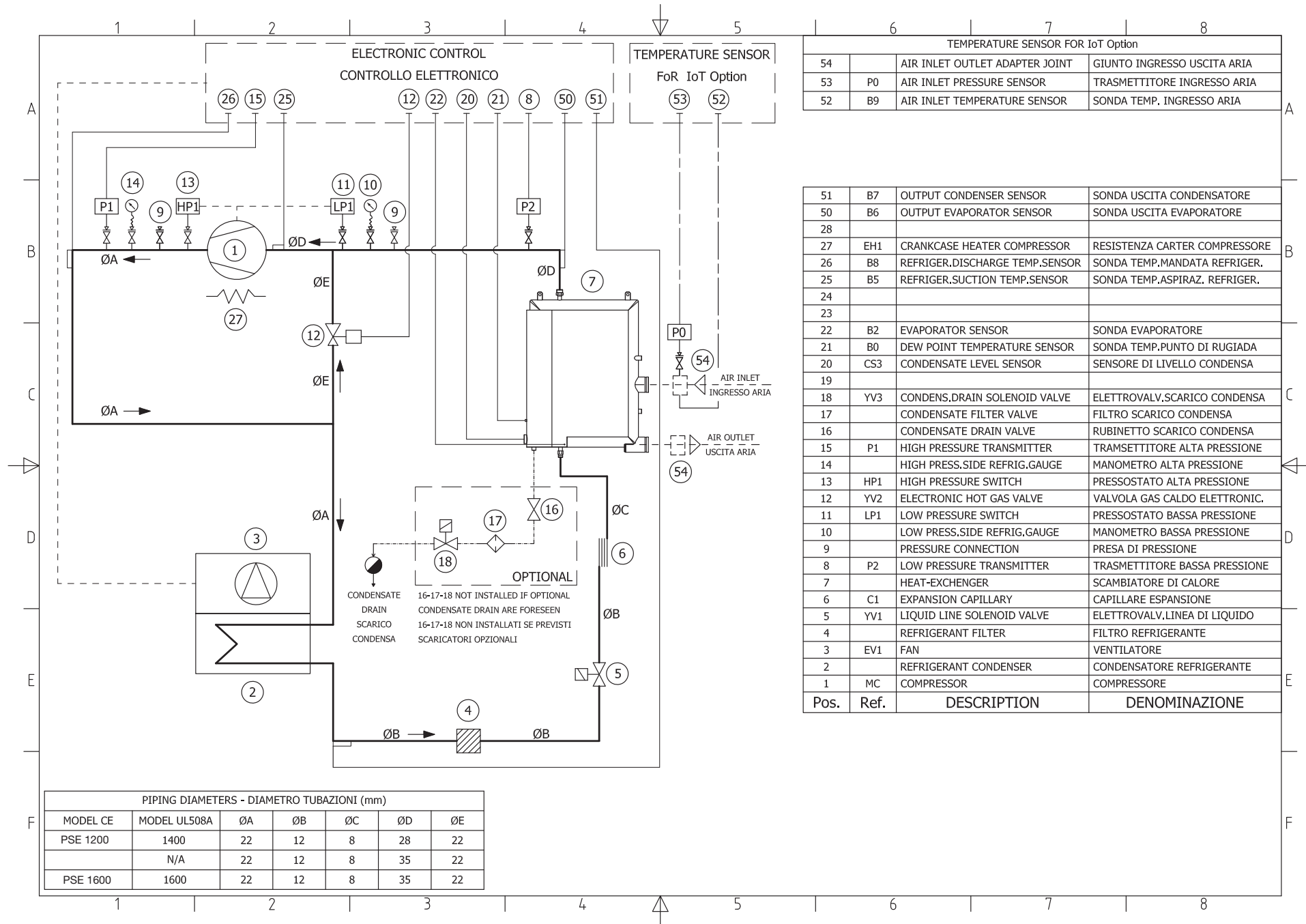



## 8.7 REFRIGERANT CIRCUIT PSE 2000-3800 Ac

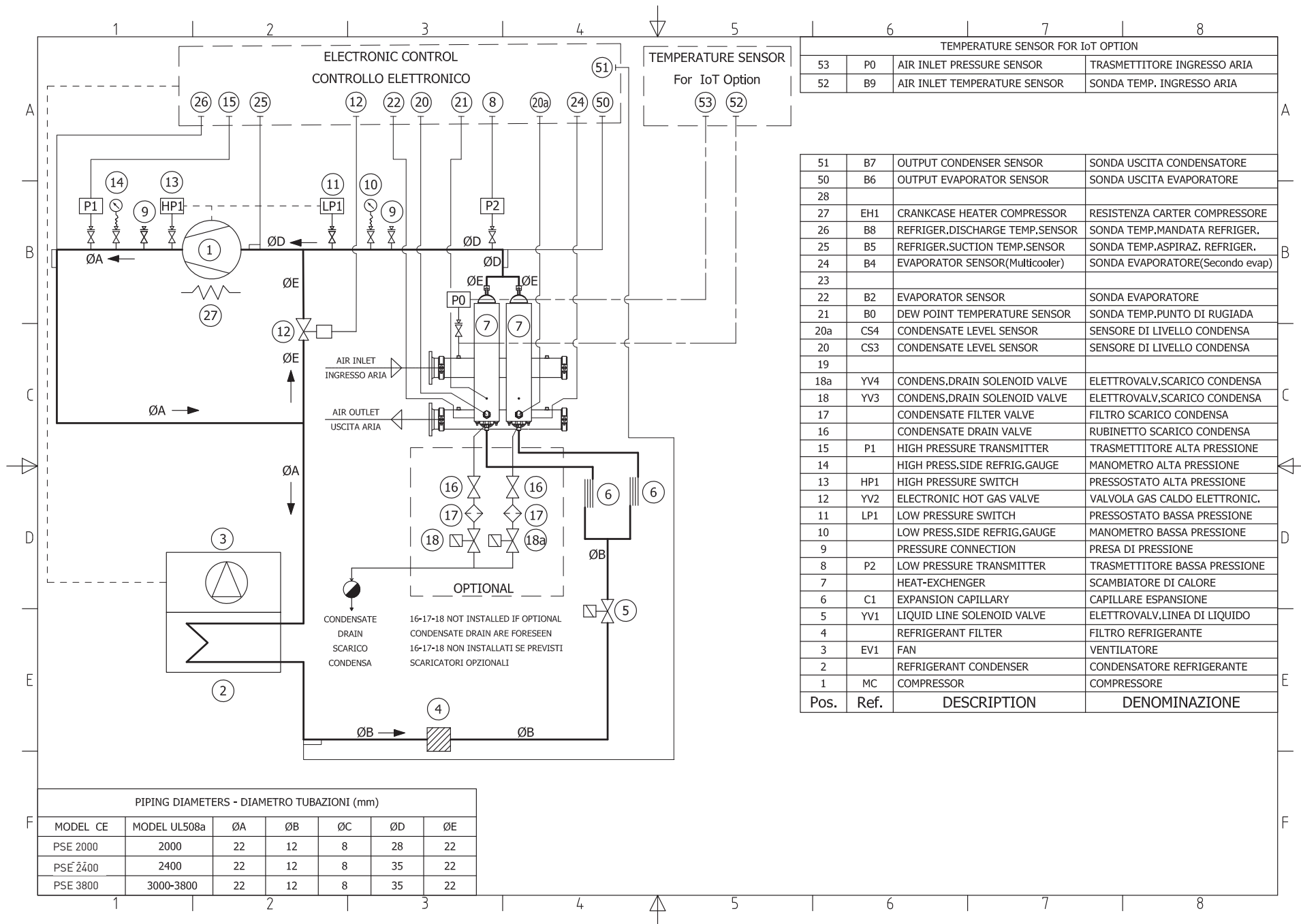

## 8.7 REFRIGERANT CIRCUIT PSE 5000-6000 Ac

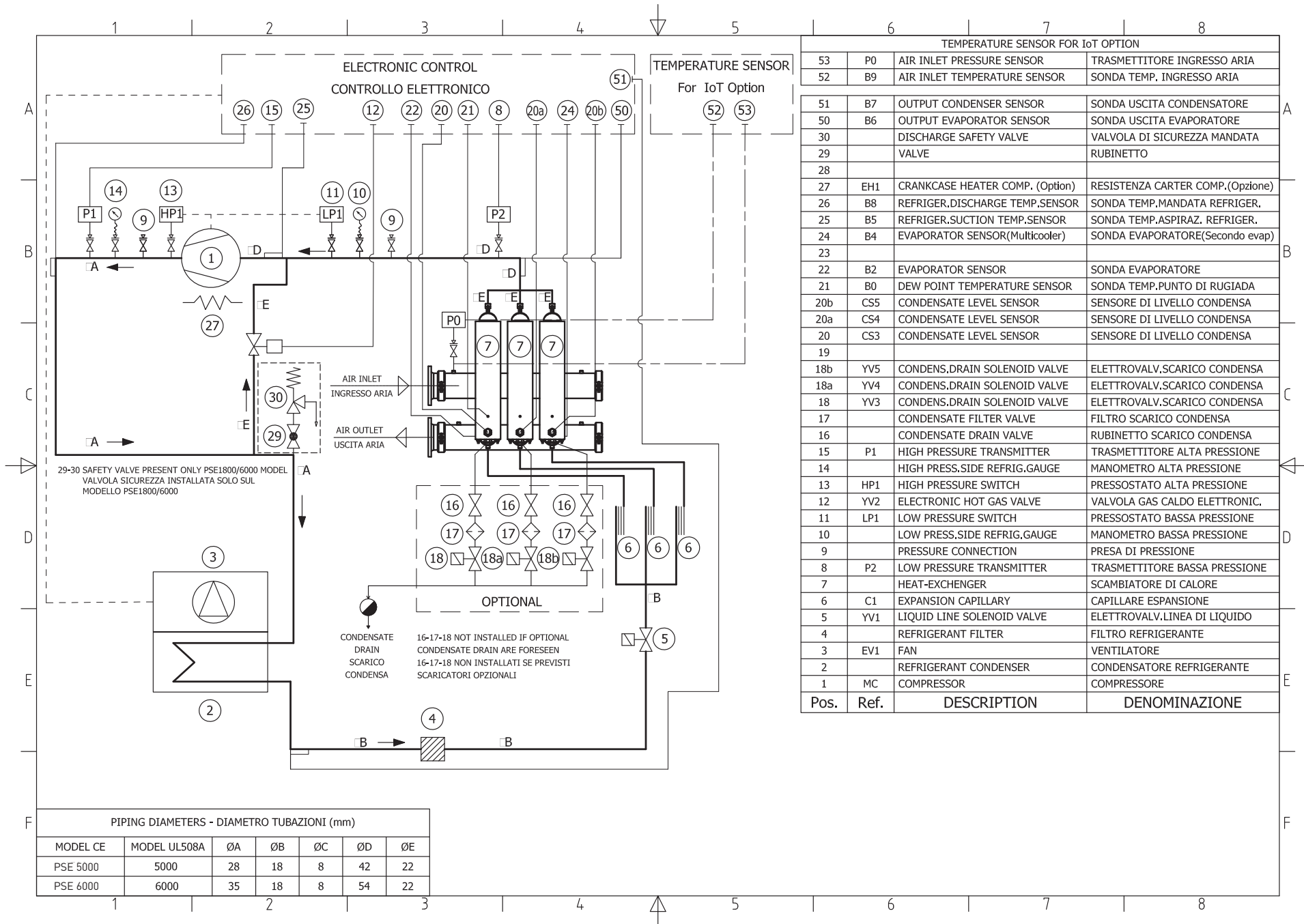

## 8.7 REFRIGERANT CIRCUIT PSE 1400-1600 Wc

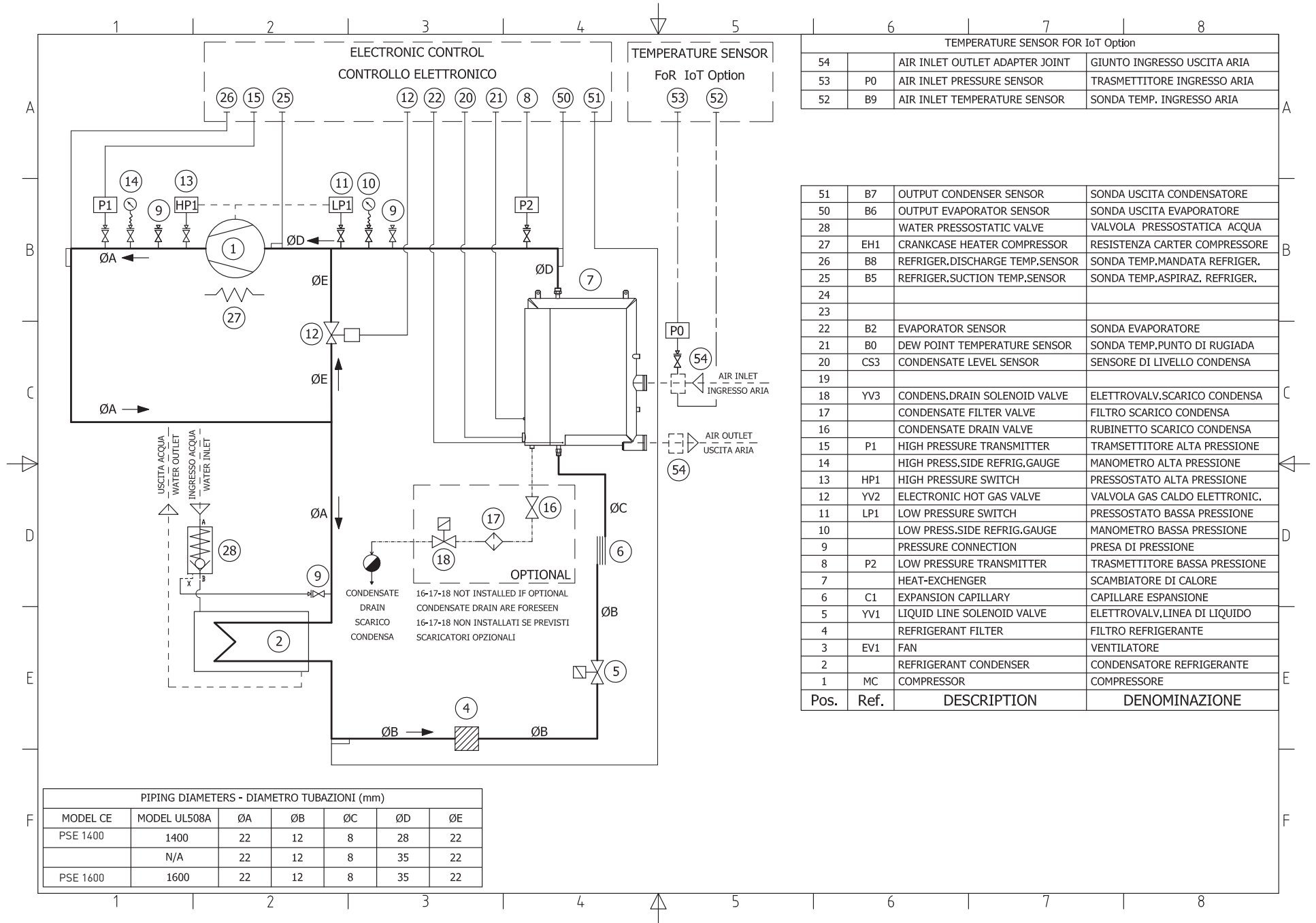

# 8.7 REFRIGERANT CIRCUIT PSE 2000-3800 Wc

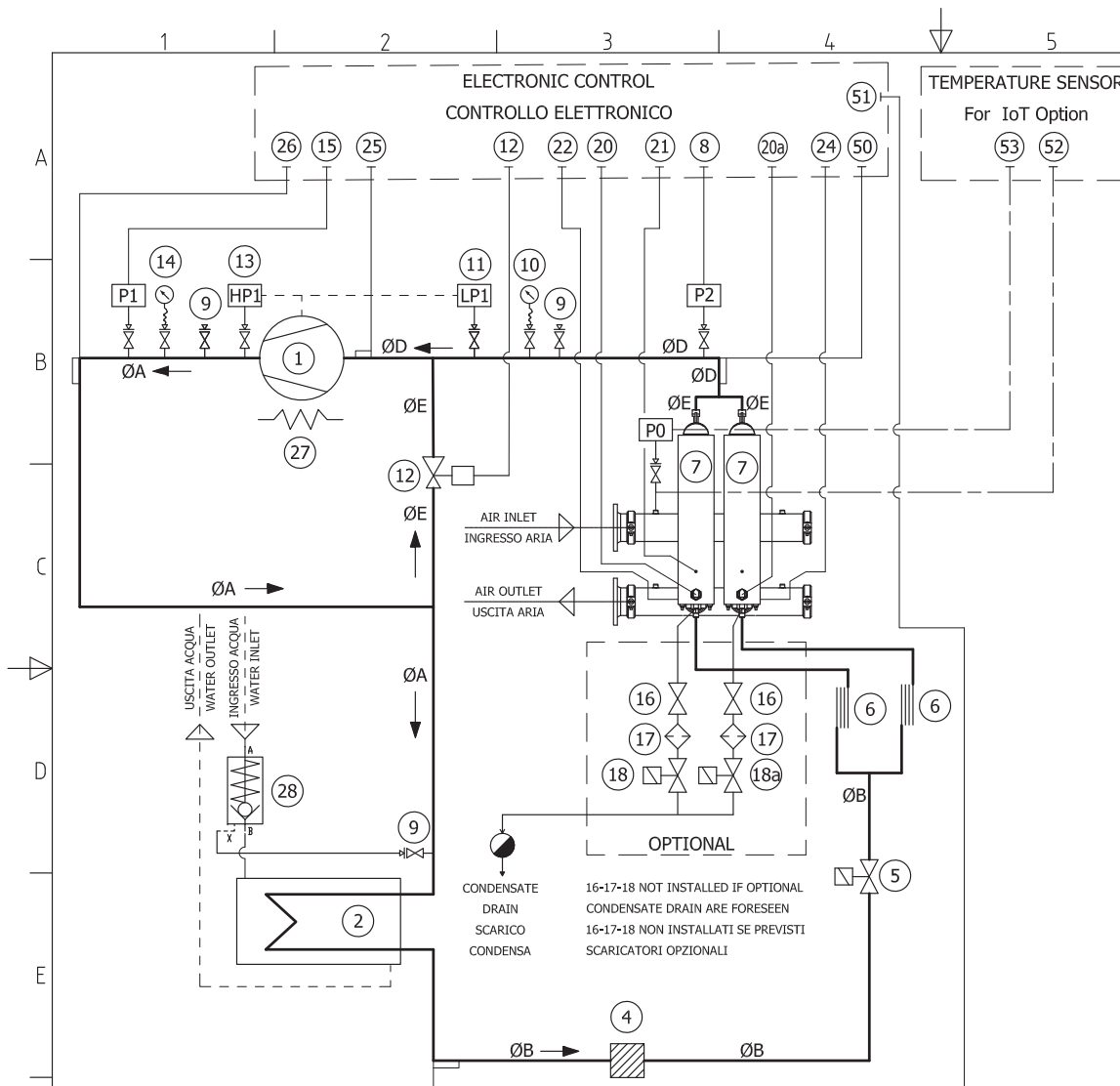

TEMPERATURE SENSOR FOR IoT OPTION			
53	P0	AIR INLET PRESSURE SENSOR	TRASMETTITORE INGRESSO ARIA
52	B9	AIR INLET TEMPERATURE SENSOR	SONDA TEMP. INGRESSO ARIA

51	B7	OUTPUT CONDENSER SENSOR	SONDA USCITA CONDENSATORE
50	B6	OUTPUT EVAPORATOR SENSOR	SONDA USCITA EVAPORATORE
28		WATER PRESSOSTATIC VALVE	VALVOLA PRESSOSTATICA ACQUA
27	EH1	CRANKCASE HEATER COMPRESSOR	RESISTENZA CARTER COMPRESSORE
26	B8	REFRIGER. DISCHARGE TEMP. SENSOR	SONDA TEMP. MANDATA REFRIGER.
25	B5	REFRIGER. SUCTION TEMP. SENSOR	SONDA TEMP. ASPIRAZ. REFRIGER.
24	B4	EVAPORATOR SENSOR (Multicooler)	SONDA EVAPORATORE (Secondo evap)
23			
22	B2	EVAPORATOR SENSOR	SONDA EVAPORATORE
21	B0	DEW POINT TEMPERATURE SENSOR	SONDA TEMP. PUNTO DI RUGIADA
20a	CS4	CONDENSATE LEVEL SENSOR	SENSORE DI LIVELLO CONDENSA
20	CS3	CONDENSATE LEVEL SENSOR	SENSORE DI LIVELLO CONDENSA
19			
18a	YV4	CONDENS. DRAIN SOLENOID VALVE	ELETTROVALV. SCARICO CONDENSA
18	YV3	CONDENS. DRAIN SOLENOID VALVE	ELETTROVALV. SCARICO CONDENSA
17		CONDENSATE FILTER VALVE	FILTRO SCARICO CONDENSA
16		CONDENSATE DRAIN VALVE	RUBINETTO SCARICO CONDENSA
15	P1	HIGH PRESSURE TRANSMITTER	TRASMETTITORE ALTA PRESSIONE
14		HIGH PRESS. SIDE REFRIG. GAUGE	MANOMETRO ALTA PRESSIONE
13	HP1	HIGH PRESSURE SWITCH	PRESSOSTATO ALTA PRESSIONE
12	YV2	ELECTRONIC HOT GAS VALVE	VALVOLA GAS CALDO ELETTRONIC.
11	LP1	LOW PRESSURE SWITCH	PRESSOSTATO BASSA PRESSIONE
10		LOW PRESS. SIDE REFRIG. GAUGE	MANOMETRO BASSA PRESSIONE
9		PRESSURE CONNECTION	PRESA DI PRESSIONE
8	P2	LOW PRESSURE TRANSMITTER	TRASMETTITORE BASSA PRESSIONE
7		HEAT-EXCHANGER	SCAMBIATORE DI CALORE
6	C1	EXPANSION CAPILLARY	CAPILLARE ESPANSIONE
5	YV1	LIQUID LINE SOLENOID VALVE	ELETTROVALV. LINEA DI LIQUIDO
4		REFRIGERANT FILTER	FILTRO REFRIGERANTE
3			
2		REFRIGERANT CONDENSER	CONDENSATORE REFRIGERANTE
1	MC	COMPRESSOR	COMPRESSORE
Pos.	Ref.	DESCRIPTION	DENOMINAZIONE

PIPING DIAMETERS - DIAMETRO TUBAZIONI (mm)

MODEL CE	MODEL UL508a	ØA	ØB	ØC	ØD	ØE
PSE 2000	2000	22	12	8	28	22
PSE 2400	2400	22	12	8	35	22
PSE 3800	3000-3800	22	12	8	35	22

# 8.7 REFRIGERANT CIRCUIT PSE 5000-6000 Wc

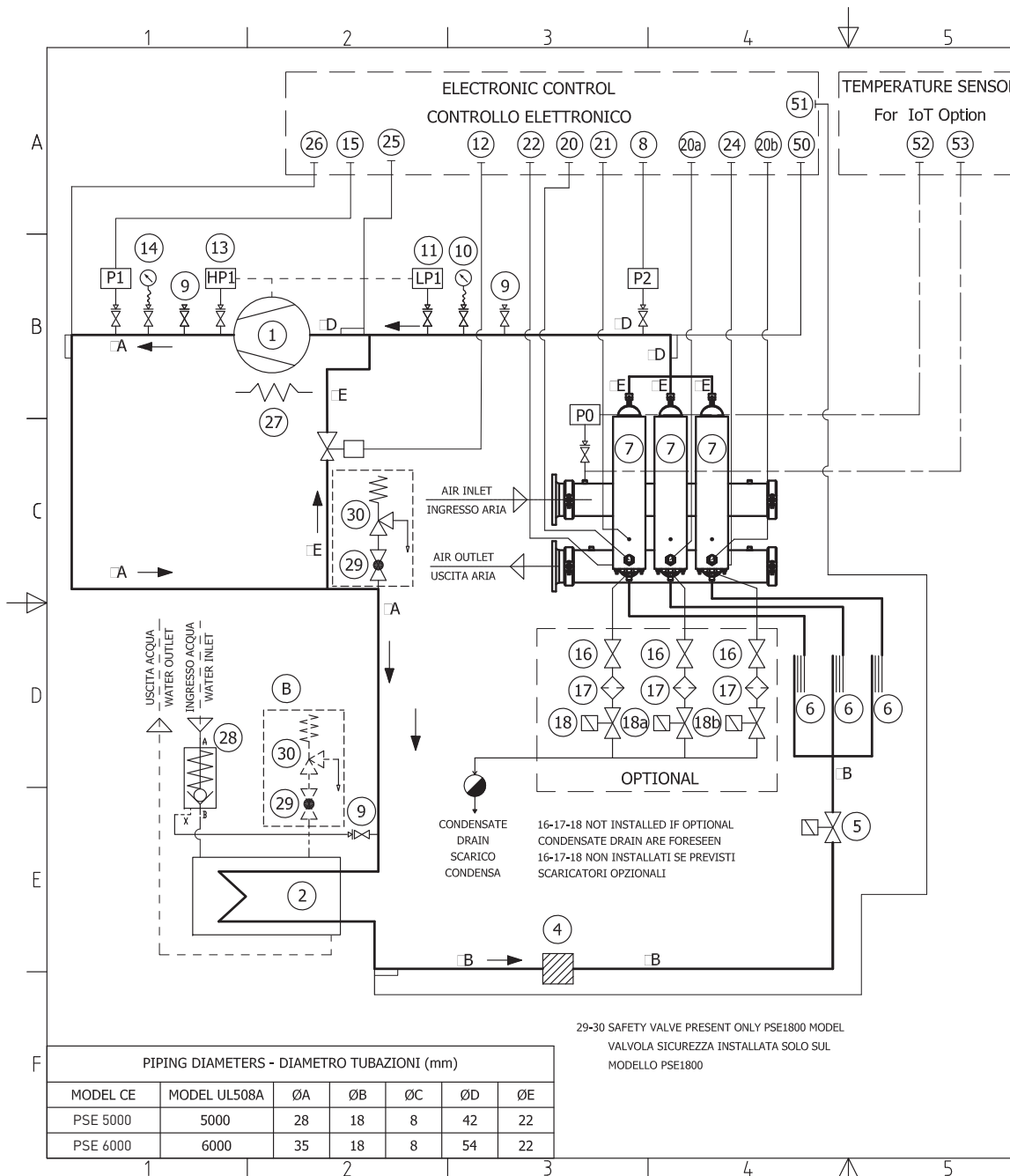

TEMPERATURE SENSOR FOR IoT OPTION			
53	P0	AIR INLET PRESSURE SENSOR	TRASMETTITORE INGRESSO ARIA
52	B9	AIR INLET TEMPERATURE SENSOR	SONDA TEMP. INGRESSO ARIA
51	B7	OUTPUT CONDENSER SENSOR	SONDA USCITA CONDENSATORE
50	B6	OUTPUT EVAPORATOR SENSOR	SONDA USCITA EVAPORATORE
30		DISCHARGE SAFETY VALVE	VALVOLA DI SICUREZZA MANDATA
29		VALVE	RUBINETTO
28			
27	EH1	CRANKCASE HEATER COMP. (Option)	RESISTENZA CARTER COMP.(Opzione)
26	B8	REFRIGER.DISCHARGE TEMP.SENSOR	SONDA TEMP.MANDATA REFRIGER.
25	B5	REFRIGER.SUCTION TEMP.SENSOR	SONDA TEMP.ASPIRAZ. REFRIGER.
24	B4	EVAPORATOR SENSOR(Multicooler)	SONDA EVAPORATORE(Secondo evap)
23			
22	B2	EVAPORATOR SENSOR	SONDA EVAPORATORE
21	B0	DEW POINT TEMPERATURE SENSOR	SONDA TEMP.PUNTO DI RUGIADA
20b	CS5	CONDENSATE LEVEL SENSOR	SENSORE DI LIVELLO CONDENSA
20a	CS4	CONDENSATE LEVEL SENSOR	SENSORE DI LIVELLO CONDENSA
20	CS3	CONDENSATE LEVEL SENSOR	SENSORE DI LIVELLO CONDENSA
19			
18b	YV5	CONDENS.DRAIN SOLENOID VALVE	ELETTROVALV.SCARICO CONDENSA
18a	YV4	CONDENS.DRAIN SOLENOID VALVE	ELETTROVALV.SCARICO CONDENSA
18	YV3	CONDENS.DRAIN SOLENOID VALVE	ELETTROVALV.SCARICO CONDENSA
17		CONDENSATE FILTER VALVE	FILTRO SCARICO CONDENSA
16		CONDENSATE DRAIN VALVE	RUBINETTO SCARICO CONDENSA
15	P1	HIGH PRESSURE TRANSMITTER	TRASMETTITORE ALTA PRESSIONE
14		HIGH PRESS.SIDE REFRIG.GAUGE	MANOMETRO ALTA PRESSIONE
13	HP1	HIGH PRESSURE SWITCH	PRESSOSTATO ALTA PRESSIONE
12	YV2	ELECTRONIC HOT GAS VALVE	VALVOLA GAS CALDO ELETTRONIC.
11	LP1	LOW PRESSURE SWITCH	PRESSOSTATO BASSA PRESSIONE
10		LOW PRESS.SIDE REFRIG.GAUGE	MANOMETRO BASSA PRESSIONE
9		PRESSURE CONNECTION	PRESA DI PRESSIONE
8	P2	LOW PRESSURE TRANSMITTER	TRASMETTITORE BASSA PRESSIONE
7		HEAT-EXCHANGER	SCAMBIATORE DI CALORE
6	C1	EXPANSION CAPILLARY	CAPILLARE ESPANSIONE
5	YV1	LIQUID LINE SOLENOID VALVE	ELETTROVALV.LINEA DI LIQUIDO
4		REFRIGERANT FILTER	FILTRO REFRIGERANTE
3			
2		REFRIGERANT CONDENSER	CONDENSATORE REFRIGERANTE
1	MC	COMPRESSOR	COMPRESSORE
Pos.	Ref.	DESCRIPTION	DENOMINAZIONE

29-30 SAFETY VALVE PRESENT ONLY PSE1800 MODEL  
VALVOLA SICUREZZA INSTALLATA SOLO SUL  
MODELLO PSE1800

PIPING DIAMETERS - DIAMETRO TUBAZIONI (mm)

MODEL CE	MODEL UL508A	ØA	ØB	ØC	ØD	ØE
PSE 5000	5000	28	18	8	42	22
PSE 6000	6000	35	18	8	54	22

DRYER SIZE	COMPRESSOR					FAN MOTOR					CRANKCASE HEATER			AUXILIARY													
	TAG	FLA [A]	Pn		LRA [A]	TAG	FLA [A]	Pn		LRA [A]	TAG	Pn		FLA [A]	Pn [A]		FLA [A]										
			kW	Hp				kW	Hp			kW	Hp		kW	Hp											
460 (1400)	MA1	12,8	8,3	5	95	MA3	1,35	0,74	1/2	9,45	EH11	0,070	--	0,15	0,3	--	1,5										
630 (1600)		19,2	10,9	7 1/2	140													2,1	1,25	1 1/2	14,7	0,075	--	0,16	0,3	--	1,5
750 (2000)		29,5	16,8	22 1/2	175																						

GENERAL DATA / DONNÉES GENERALES

DRYER SIZE	460	630	750
Pn [kW]	9,0	11,7	18,0
FLA [A]	14,2	20,6	31,6
MCA [A]	17,5	25,5	40
MOP [A]	30	40	65

ITEM	398H316910Y001 398H316911Y001 398H316912Y001
Supply Voltage Tension d'alimentation	575V - 3Ph - 60Hz
Control Voltage Tension auxiliaire	24Vac / 24Vdc
Enclosed type	TYPE 1
Residual current switch and fuses Disjoncteur et fusibles à courant résiduel	RCCB Id 0.3A class A and Fuses CC / J
SCCR 460-750 SCCR (1400-2000)	50 kA
Grounding Mise à la terre	Solidly grounded
Additional Opzioni	/

ELECTRICAL SUPPLY LINE - LINEA ALIMENTAZIONE  
575V/3Ph/60Hz

CABLES SIZE - DIMENSIONI CAVI  
SEE TABLE (MCA) - VEDERE TABELLA (MCA)

SH	DESCRIPTION	DESCRIPTION
1	Electrical data	Données techniques
2	Electrical data	Données techniques
3	Power circuit	Circuit d'alimentation
4	Auxiliary circuits	Circuit auxiliaire
5	Auxiliary circuits	Circuit auxiliaire
6	Auxiliary circuits	Circuit auxiliaire
7	Auxiliary circuits	Circuit auxiliaire
8	Auxiliary circuits	Circuit auxiliaire
9	Auxiliary circuits	Circuit auxiliaire
10	Auxiliary circuits	Circuit auxiliaire
11	Auxiliary circuits	Circuit auxiliaire
12	Customer interface	Interface client
13	Terminal blocks	Blocs terminaux
14	Terminal blocks	Blocs terminaux
15	Electrical panel layout	Planimétrie du panneau électrique
16	Components list	Liste de composants
17	Components list	Liste de composants
18	Components list	Liste de composants
19	Fuses list	Liste des fusibles
20	On machine	Sur machine
21	Cables list	Liste des cables
22	Cables list	Liste des cables
23	Components list	Liste des cables
24	Components list	Liste des cables
25	Cabinet	Charpenterie

	1	2	3	4	5	6	7	8
A	NFPA	IEC	DESCRIZIONE	NFPA	IEC	DESCRIZIONE	Tightening Torque - Serrage du couple	
							DRYER SIZE 460-520	
B	NFPA	IEC	DESCRIZIONE	NFPA	IEC	DESCRIZIONE	Nm	In*Lb
							QS1	6
C	NFPA	IEC	DESCRIZIONE	NFPA	IEC	DESCRIZIONE	Qm1	15,0
							Qm1(aux)	1
D	NFPA	IEC	DESCRIZIONE	NFPA	IEC	DESCRIZIONE	Km1	28,9
							Km1(aux)	3,2
E	NFPA	IEC	DESCRIZIONE	NFPA	IEC	DESCRIZIONE	Km3	10,6
							Km3(aux)	1,2
F	NFPA	IEC	DESCRIZIONE	NFPA	IEC	DESCRIZIONE	E0	53,1
							fu(10,3X38)	2,3
							Fv6	7,1
							A1,A2,A3(in)	1,8
							A1,A2,A3(out)	5,3

Designation Color in according to UL508A		
Colour Abbreviations in according to IEC 60757		
WIRING	COLOR	CROSS SECTION
Power circuit Circuito di Potenza	BLACK - BK	as circuit diagram indication
Control line at 230-24Vac Linea di Controllo a 230-24Vac	RED - RD	
Control line at 24Vdc Linea di Controllo a 24Vdc	DARK BLUE - DBU	
Analog signal Segnali Analogici	WHITE - WH VIOLET - VT BLUE - BU	
Potential free contact Contatti Puliti	ORANGE - OR	
Conductor not disconnected Conduttore non sezionati		
Ground or Earth connection Connessioni di Terra	GREEN/YELLOW - GN/YE	

Tightening Torque - Serrage du couple		
DRYER SIZE 630-1800		
	Nm	In*Lb
QS1	6	53,1
Qm1	3,3	29,2
Qm1(aux)	1	8,9
Km1	3,3	29,2
Km1(aux)	1,2	10,6
Km3	1,2	10,6
Km3(aux)	1,2	10,6
E0	6	53,1
fu(10,3X38)	2,3	20,4
fu(5X20)	0,5	4,4
Fv6	0,8	7,1
A1,A2,A3(in)	0,2	1,8
A1,A2,A3(out)	0,6	5,3



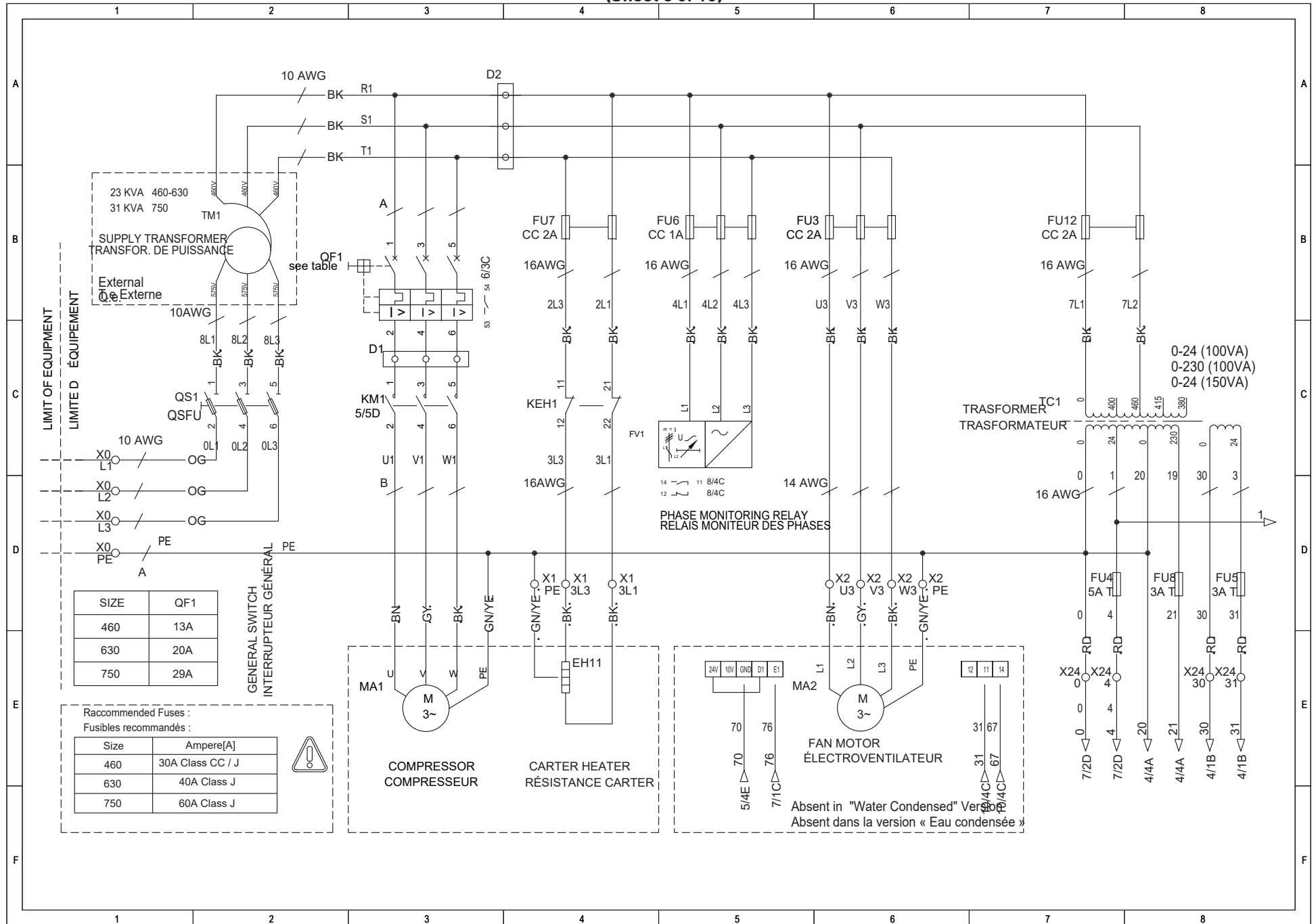

# 8.8 WIRING DIAGRAM PSE 1400-2000 (575V)

(Sheet 4 of 15)

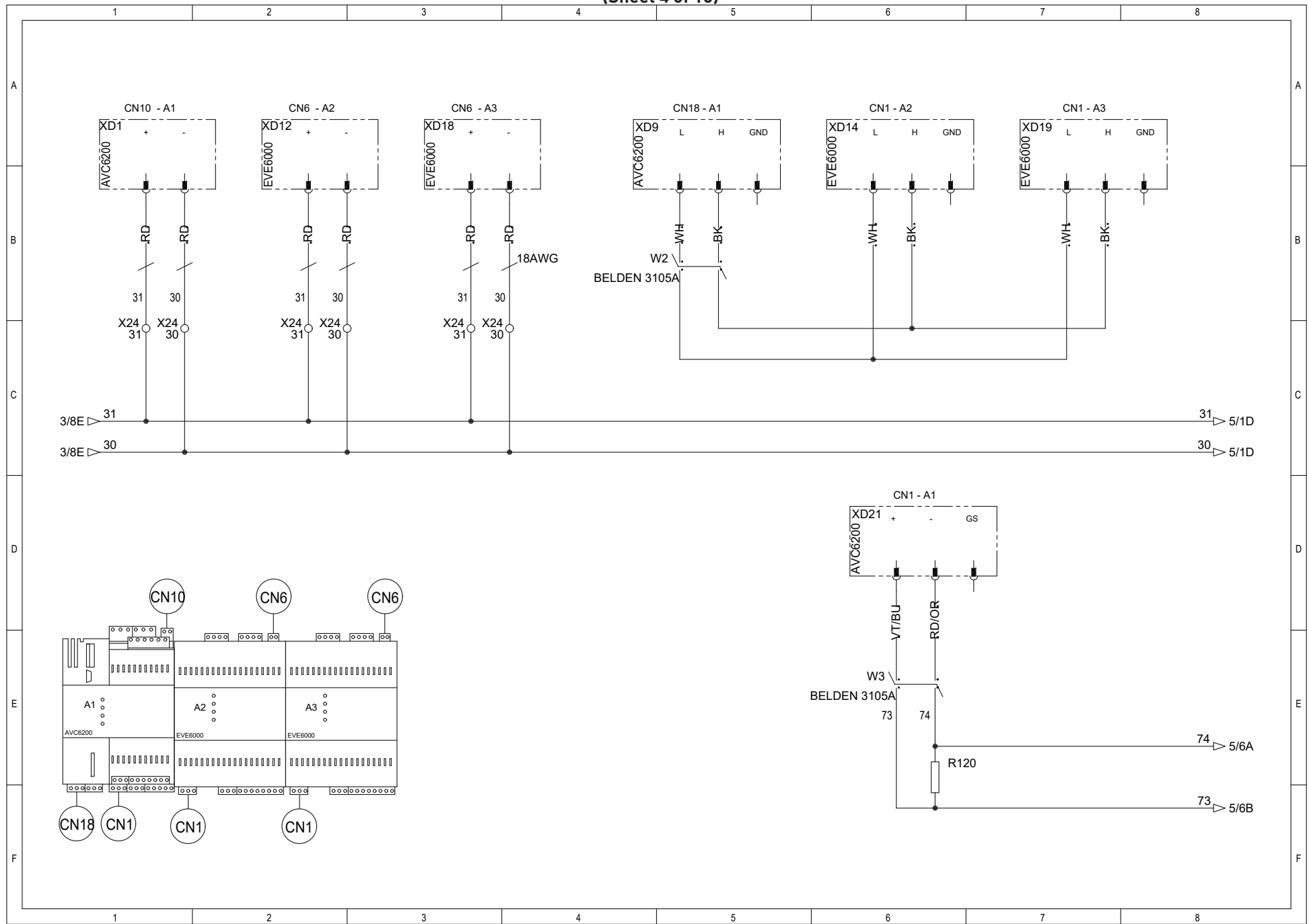

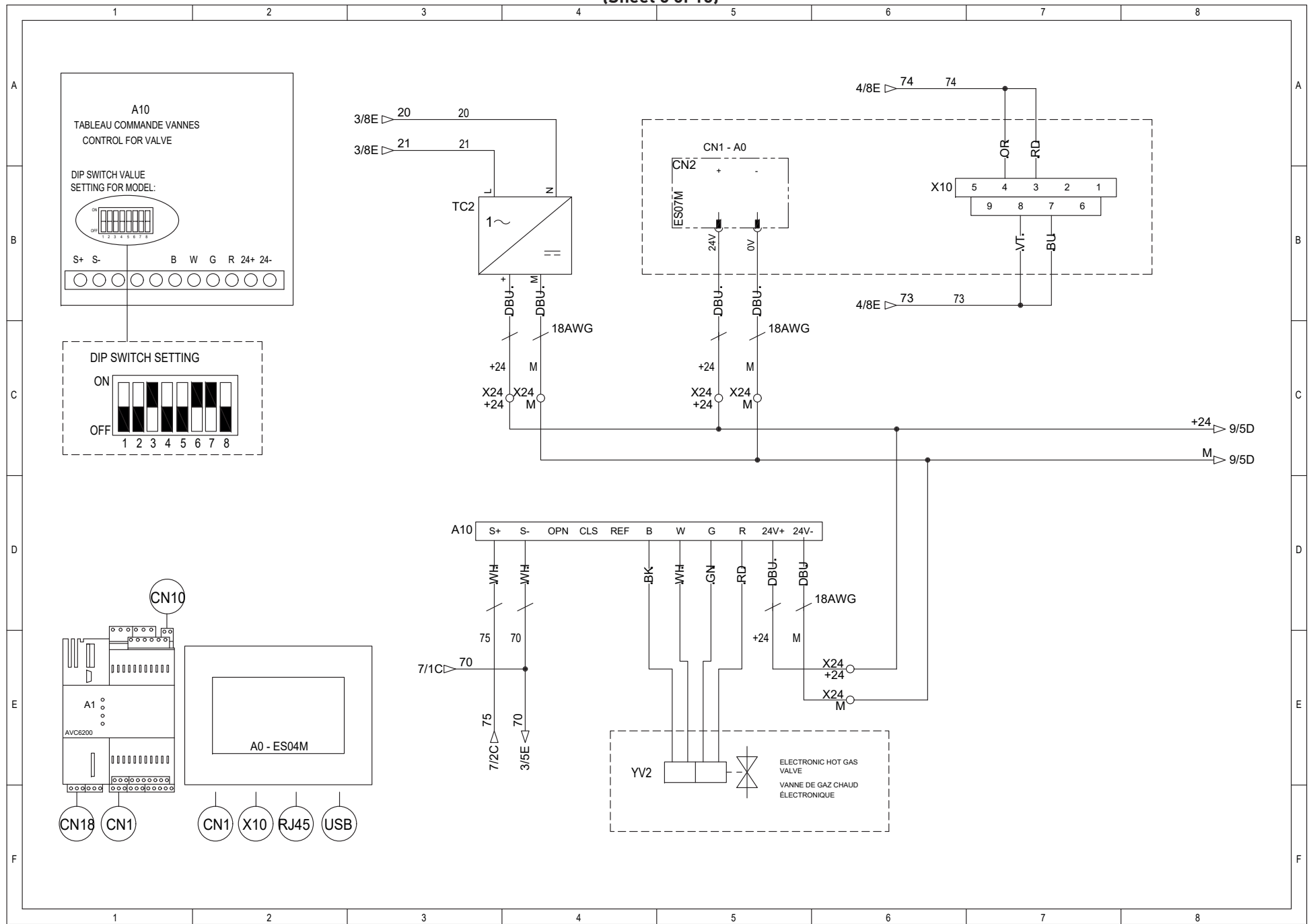

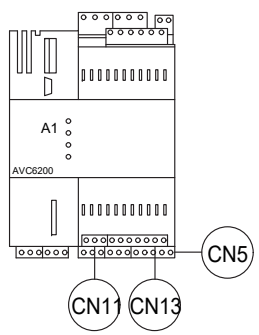
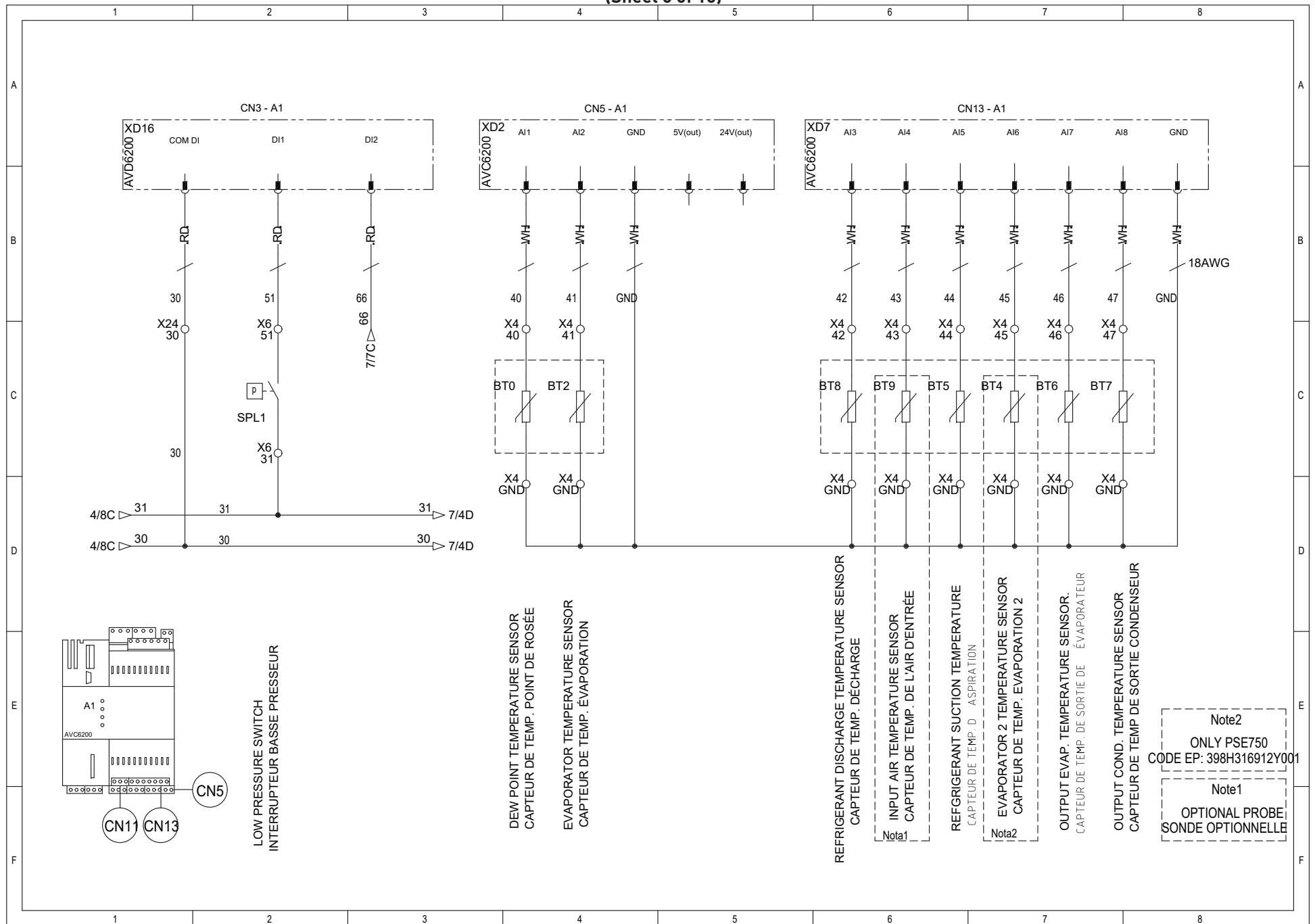

LOW PRESSURE SWITCH  
INTERRUPTEUR BASSE PRESSEUR

DEW POINT TEMPERATURE SENSOR  
CAPTEUR DE TEMP. POINT DE ROSEE

EVAPORATOR TEMPERATURE SENSOR  
CAPTEUR DE TEMP. EVAPORATION

REFRIGERANT DISCHARGE TEMPERATURE SENSOR  
CAPTEUR DE TEMP. DECHARGE

INPUT AIR TEMPERATURE SENSOR  
CAPTEUR DE TEMP. DE L'AIR D'ENTREE

REFRIGERANT SUCTION TEMPERATURE  
CAPTEUR DE TEMP. D'ASPIRATION

EVAPORATOR 2 TEMPERATURE SENSOR  
CAPTEUR DE TEMP. EVAPORATION 2

OUTPUT EVAP. TEMPERATURE SENSOR.  
CAPTEUR DE TEMP. DE SORTIE DE EVAPORATEUR

OUTPUT COND. TEMPERATURE SENSOR  
CAPTEUR DE TEMP. DE SORTIE CONDENSEUR

Note2  
ONLY PSE750  
CODE EP: 398H316912Y001

Note1  
OPTIONAL PROBE  
SONDE OPTIONNELLE

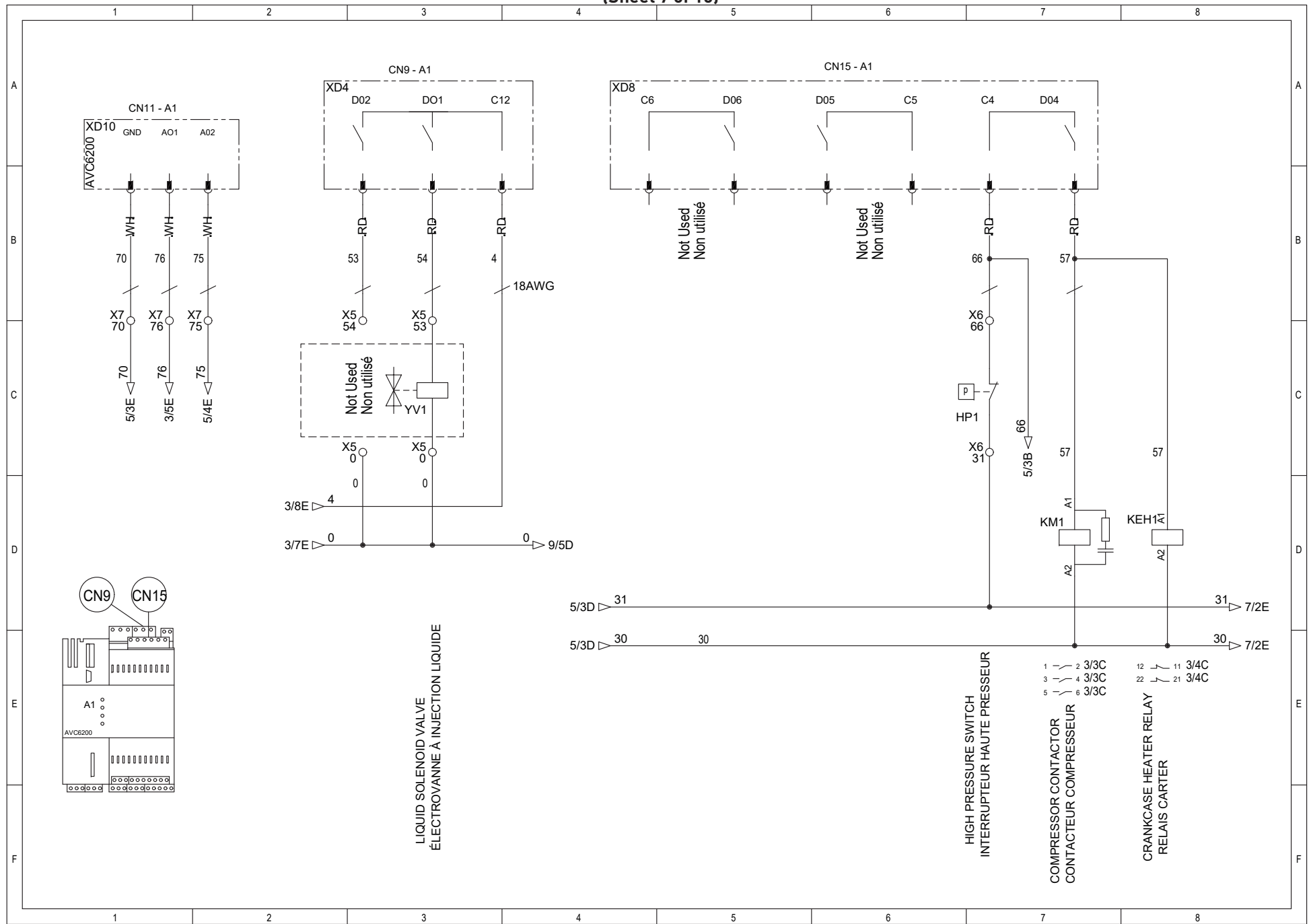

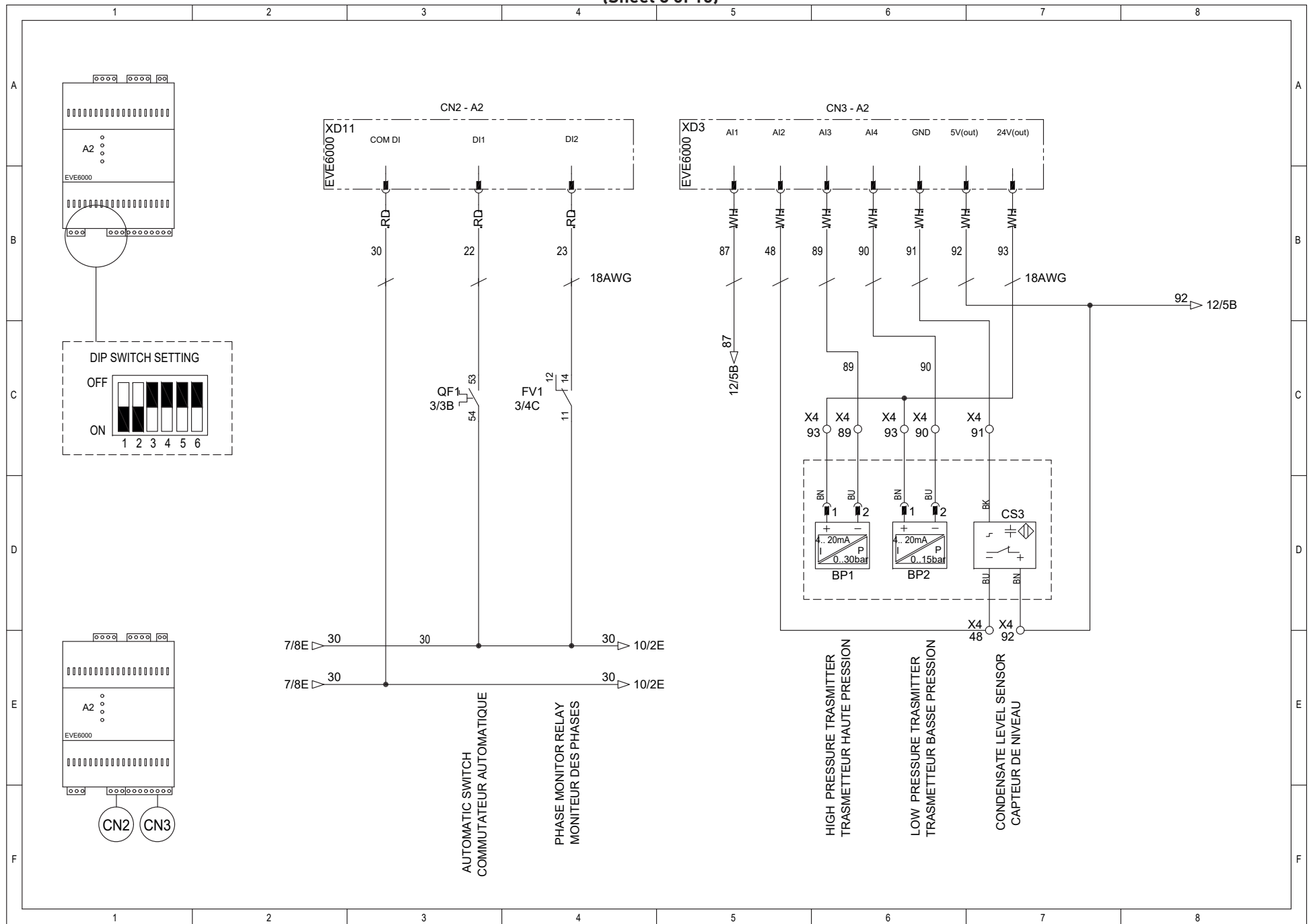

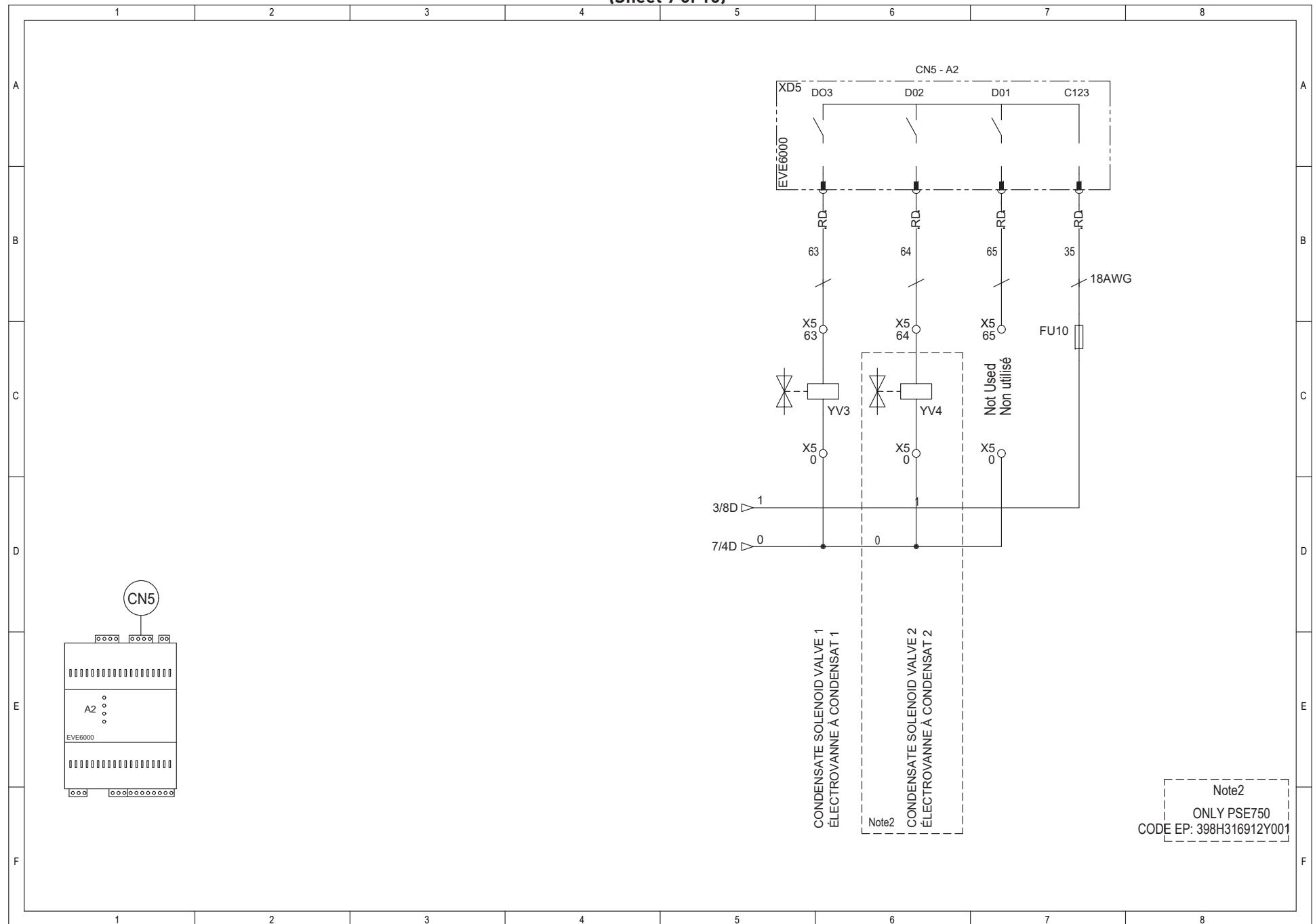

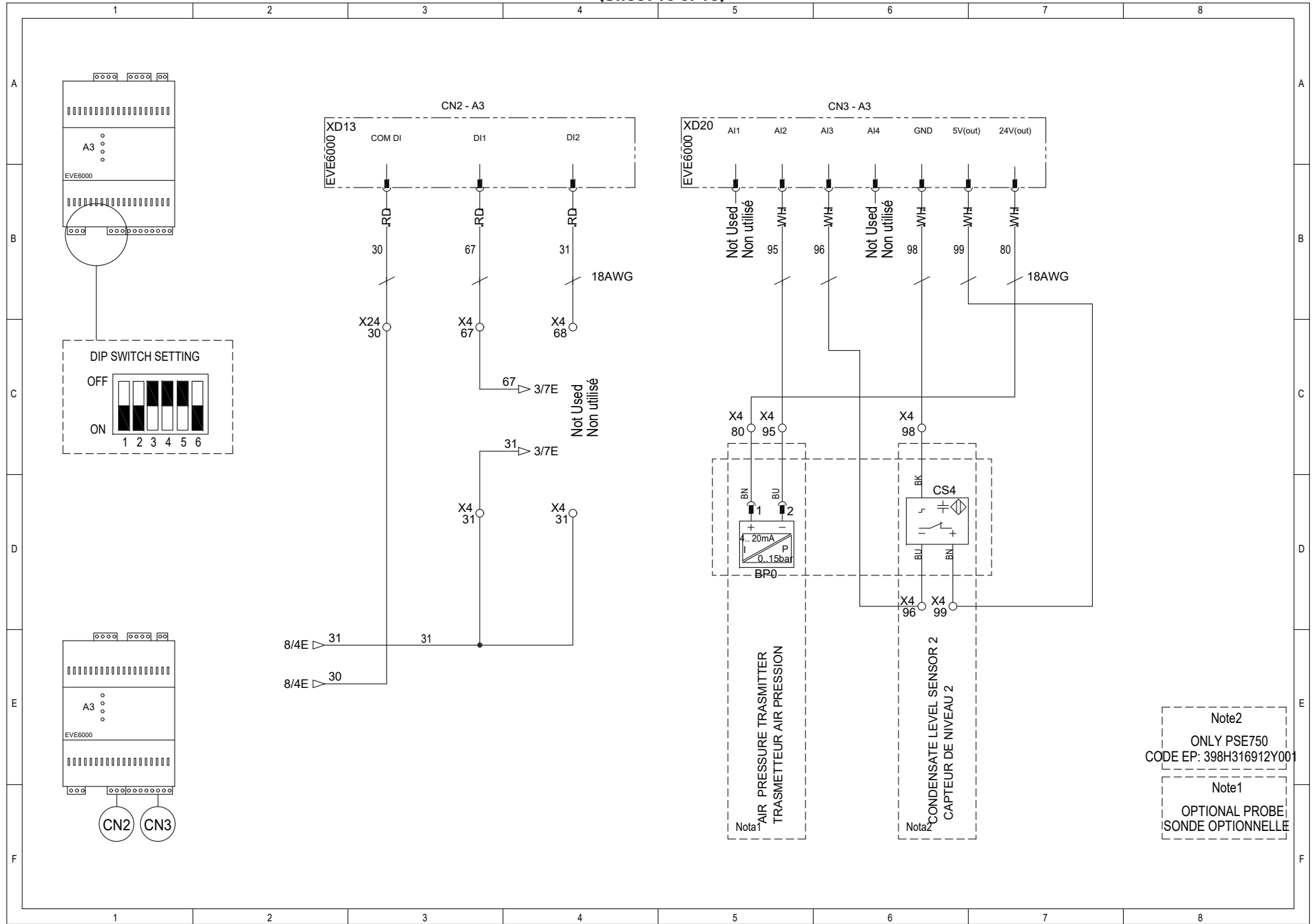

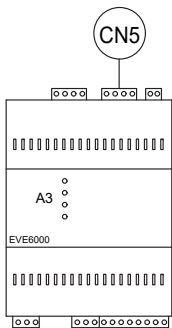
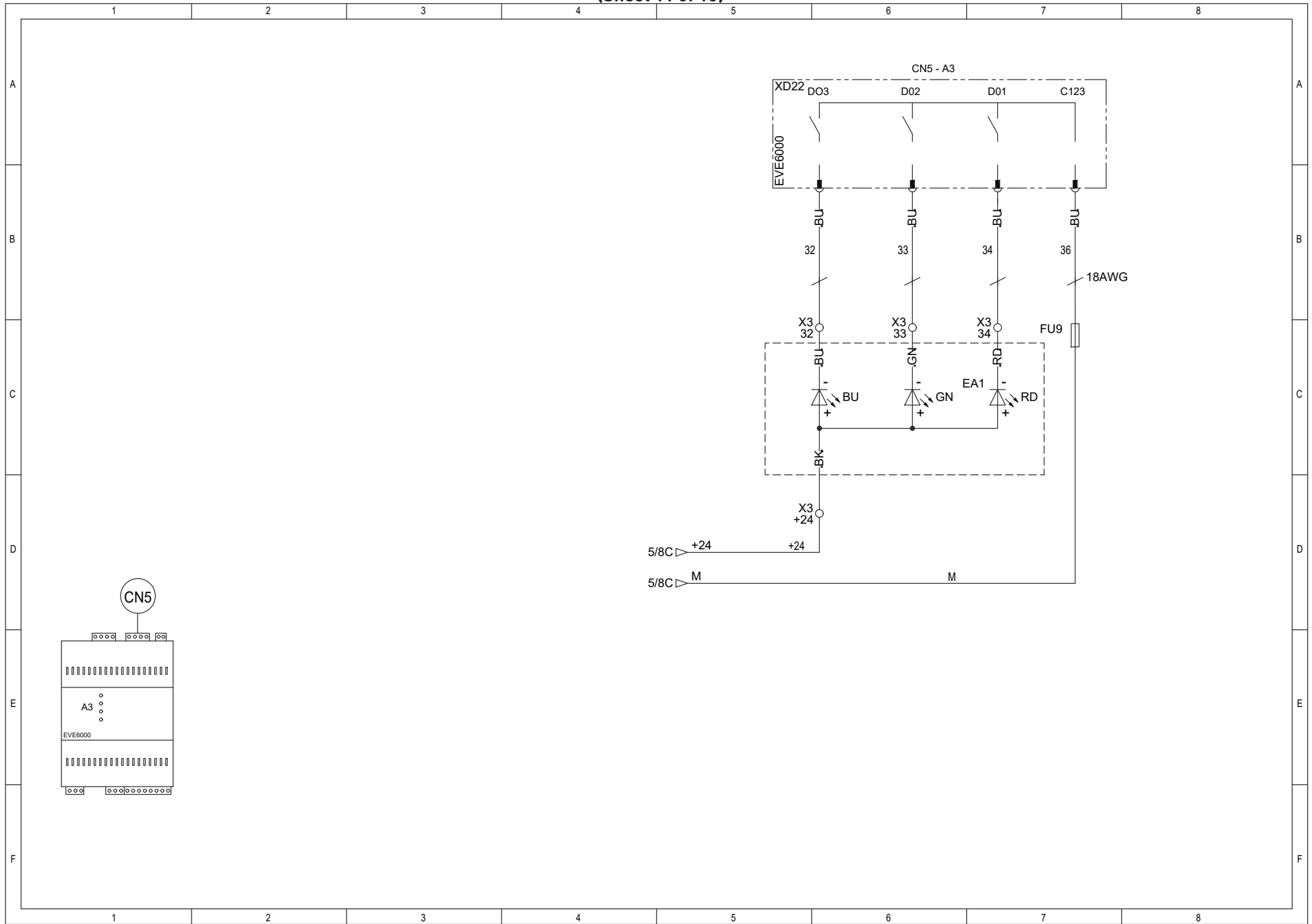



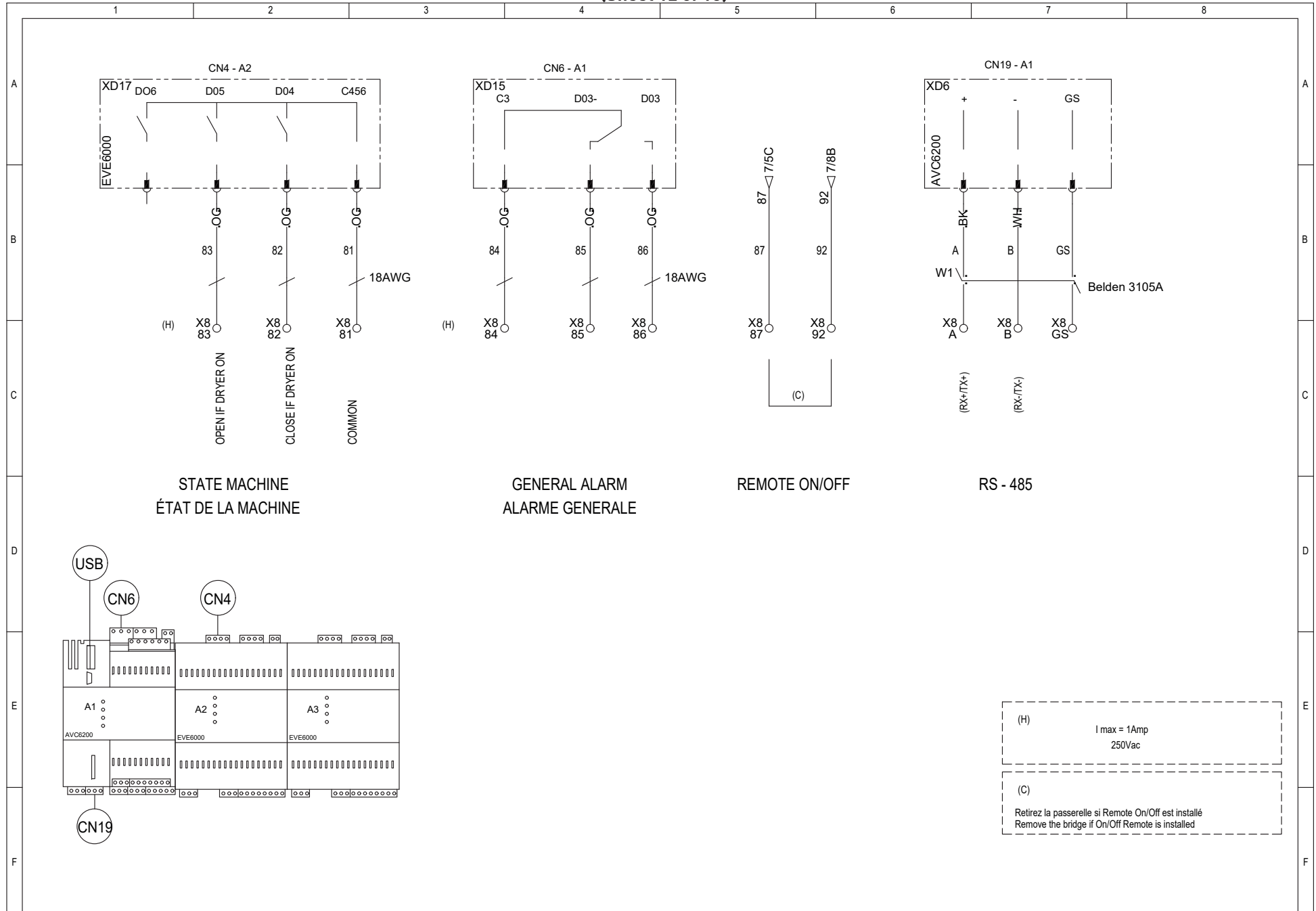





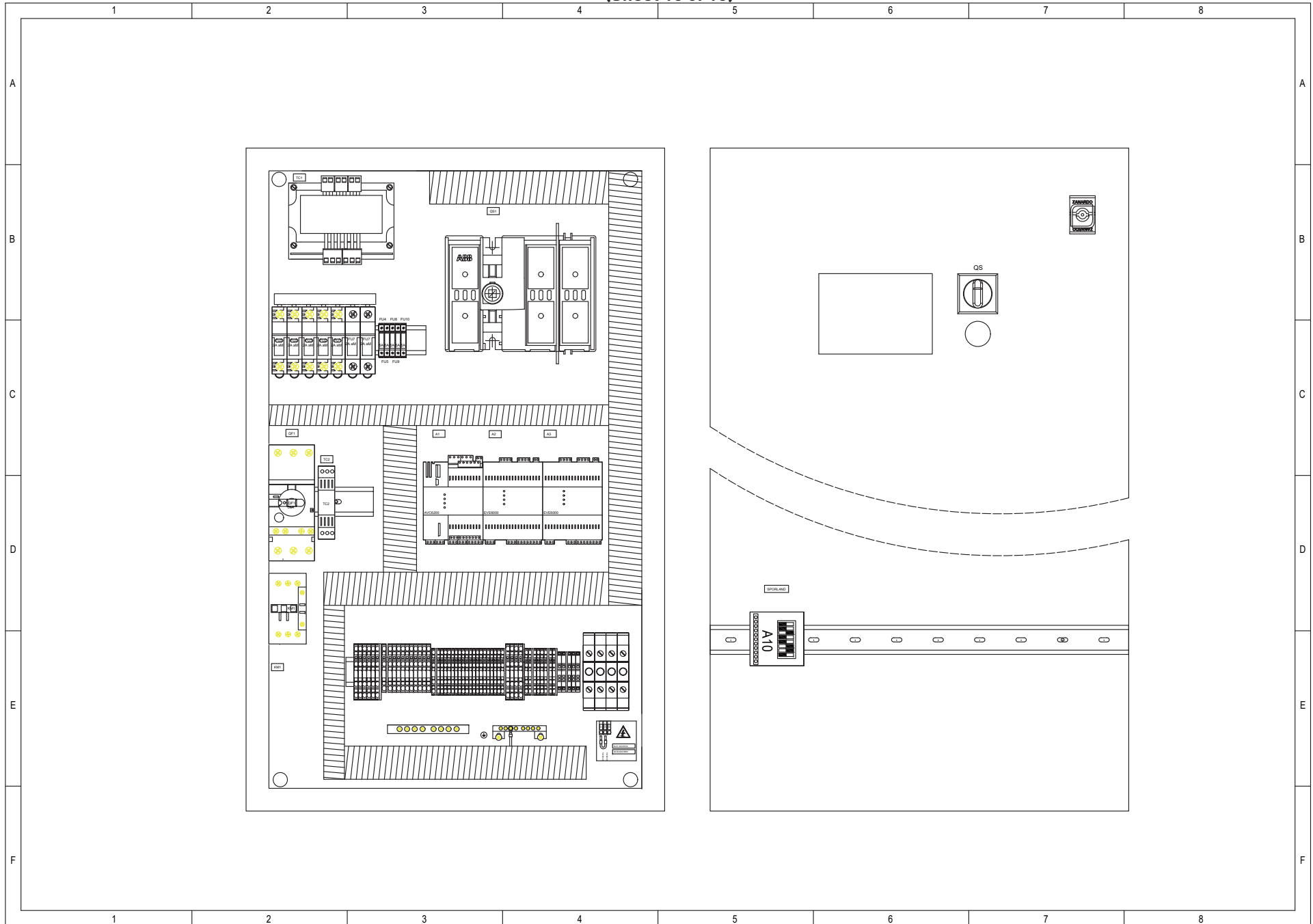

DRYER SIZE	COMPRESSOR					FAN MOTOR					CRANKCASE HEATER			AUXILIARY			
	TAG	FLA [A]	Pn		LRA [A]	TAG	FLA [A]	Pn		LRA [A]	TAG	Pn		FLA [A]	Pn [A]		FLA [A]
			kW	Hp				kW	Hp			kW	Hp		kW	Hp	
900 (2400)	MA1	35,7	23	30	125	MA3	2,1	1,25	1 1/2	14,7	EH11	0,130	--	0,28	0,3	--	1,5
1200 (3000) (3800)																	
1500 (5000)	MA1	49,3	29,2	30	270	MA3	3	1,85	1 1/2	21	EH11	0,130	--	0,28	0,35	--	1,5
1800 (6000)																	

GENERAL DATA / DONNÉES GENERALES

ELECTRICAL PANEL	398H316913Y001		398H316914Y001	
DRYER SIZE	900	1200	1500	1800
Pn [kW]	24,2		31	35,1
FLA [A]	37,8		52,3	59,4
MCA [A]	47,0		65	74,0
MOP [A]	80,0		110	125,0

ITEM	398H316913Y001 398H316914Y001
Supply Voltage Tension d'alimentation	575V - 3Ph - 60Hz
Control Voltage Tension auxiliaire	24Vac / 24Vdc
Enclosed type	TYPE 1
Residual current switch and fuses Disjoncteur et fusibles à courant résiduel	RCCB Id 0.3A class A and Fuses CC / J
SCCR 460-630 SCCR (1400-1600)	50 kA
Grounding Mise à la terre	Solidly grounded
Additional Opzioni	/

SH	DESCRIPTION	DESCRIPTION
1	Electrical data	Données techniques
2	Electrical data	Données techniques
3	Power circuit	Circuit d'alimentation
4	Auxiliary circuits	Circuit auxiliaire
5	Auxiliary circuits	Circuit auxiliaire
6	Auxiliary circuits	Circuit auxiliaire
7	Auxiliary circuits	Circuit auxiliaire
8	Auxiliary circuits	Circuit auxiliaire
9	Auxiliary circuits	Circuit auxiliaire
10	Auxiliary circuits	Circuit auxiliaire
11	Auxiliary circuits	Circuit auxiliaire
12	Customer interface	Interface client
13	Terminal blocks	Blocs terminaux
14	Terminal blocks	Blocs terminaux
15	Electrical panel layout	Planimétrie du panneau électrique
16	Components list	Liste de composants
17	Components list	Liste de composants
18	Components list	Liste de composants
19	Fuses list	Liste des fusibles
20	On machine	Sur machine
21	Cables list	Liste des cables
22	Cables list	Liste des cables
23	Components list	Liste des cables
24	Components list	Liste des cables
25	Cabinet	Charpenterie

ELECTRICAL SUPPLY LINE - LINEA ALIMENTAZIONE  
575V/3Ph/60Hz

CABLES SIZE - DIMENSIONI CAVI  
SEE TABLE (MCA) - VEDERE TABELLA (MCA)

	1	2	3	4	5	6	7	8	
A	NFPA	IEC	DESCRIZIONE	NFPA	IEC	DESCRIZIONE	Tightening Torque - Serrage du couple		
							DRYER SIZE 460-520		
	DS	QS	GENERAL SWITCH	OM	FV	FV		Nm	In*Lb
			DÉBRANCHEUR PRINCIPAL				AUTOMATIC SWITCH	QS1	6
	CB	QM	AUTOMATIC THERMAL SWITCH	FV	FV	FV	QM1	1,7	15,0
			INTERRUPTEUR THERMIQUE AUTOMATIQUE				SWITCH AUTOMATIQUE	QM1(aux)	1
	M	KM	COMPRESSOR CONTACT	FV	FV	FV	QM1	3,2	28,9
			CONTACT COMPRESSEUR				PHASE MONITORING RELAY	KM1	1,2
	MOT	MA	MOTOR	XM	TM	TM	KM1(aux)	1,2	10,6
			MOTEUR				RELAIS DE SURVEILLANCE DE PHASE	KM3	1,2
FU	FU	FUSES	DS	OS	OS	KM3(aux)	1,2	10,6	
		FUSIBLES				SUPPLY TRANSFORMER	E0	6	53,1
CR	KA	NC RELAY	DS	OS	OS	fu(10,3X38)	2,3	20,4	
		CF RELAIS				TRANSFORMATEUR DE PUISSANCE	fu(5X20)	0,5	4,4
CR	KA	NO RELAY	DS	OS	OS	FV6	0,8	7,1	
		OC RELAIS				GENERAL SWITCH	A1,A2,A3(in)	0,2	1,8
XF	XF	TRANSFORMER	DS	OS	OS	A1,A2,A3(out)	0,6	5,3	
		TRANSFORMATEUR				DÉBRANCHEUR PRINCIPAL			
PS	SP	HIGH PRESSURE SWITCH	DS	OS	OS	Tightening Torque - Serrage du couple			
		PRESSOSTAT HAUTE PRESSION				DRYER SIZE 630-1800			
PS	SP	LOW PRESSURE SWITCH	DS	OS	OS		Nm	In*Lb	
		PRESSOSTAT BASSE PRESSION				QS1	6	53,1	
LS	SL	CONDENSATE LEVEL SENSOR	DS	OS	OS	QM1	3,3	29,2	
		CAPTEUR DE NIVEAU DE CONDENSAT				QM1(aux)	1	8,9	
SOL	YV	SOLENOID VALVE	DS	OS	OS	KM1	3,3	29,2	
		ELECTROVANNE				KM1(aux)	1,2	10,6	
CR	KA	RELAY COIL	DS	OS	OS	KM3	1,2	10,6	
		RELAIS DE BOBINE				KM3(aux)	1,2	10,6	
M	KM	CONTACTOR COIL	DS	OS	OS	E0	6	53,1	
		CONTACTEUR DE BOBINE				fu(10,3X38)	2,3	20,4	
RA	BT	TEMPERATURE SENSOR	DS	OS	OS	fu(5X20)	0,5	4,4	
		CAPTEUR DE TEMPÉRATURE				FV6	0,8	7,1	
TB	X	THERMINAL BLOCK	DS	OS	OS	A1,A2,A3(in)	0,2	1,8	
		PINCE				A1,A2,A3(out)	0,6	5,3	
RE	EH	CARTER HEATER	DS	OS	OS				
		RÉSISTANCE AU CARTER							
PJ	PJ	SOCKET	DS	OS	OS				
		PRISE							

Designation Color in according to UL508A		
Colour Abbreviations in according to IEC 60757		
WIRING	COLOR	CROSS SECTION
Power circuit Circuito di Potenza	BLACK - BK	as circuit diagram indication
Control line at 230-24Vac Linea di Controllo a 230-24Vac	RED - RD	
Control line at 24Vdc Linea di Controllo a 24Vdc	DARK BLUE - DBU	
Analog signal Segnali Analogici	WHITE - WH	
	VIOLET - VT	
	BLUE - BU	
Potential free contact Contatti Puliti	ORANGE - OR	
Conductor not disconnected Conduttore non sezionati		
Ground or Earth connection Connessioni di Terra	GREEN/YELLOW - GN/YE	

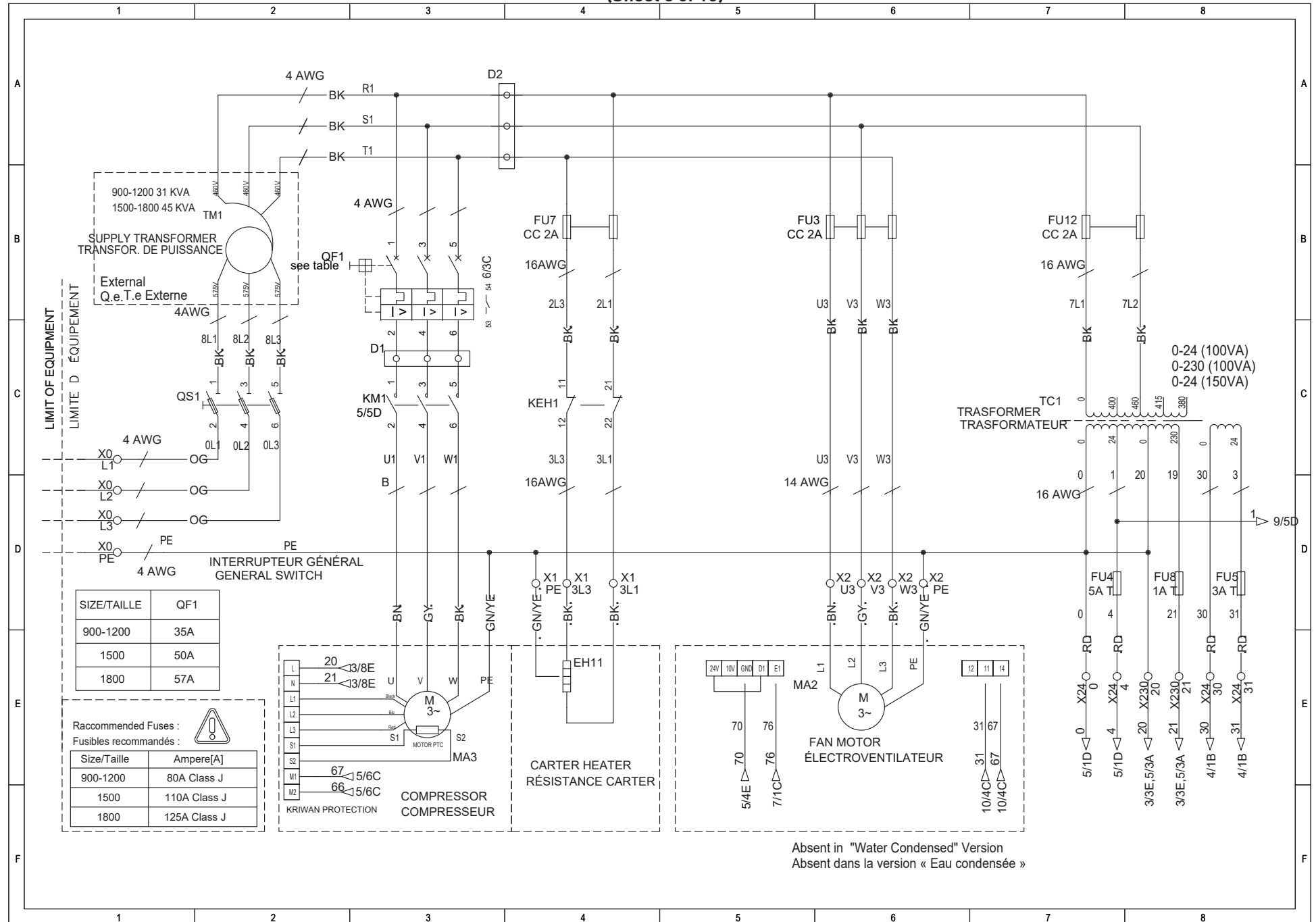

Absent in "Water Condensed" Version  
Absent dans la version « Eau condensée »

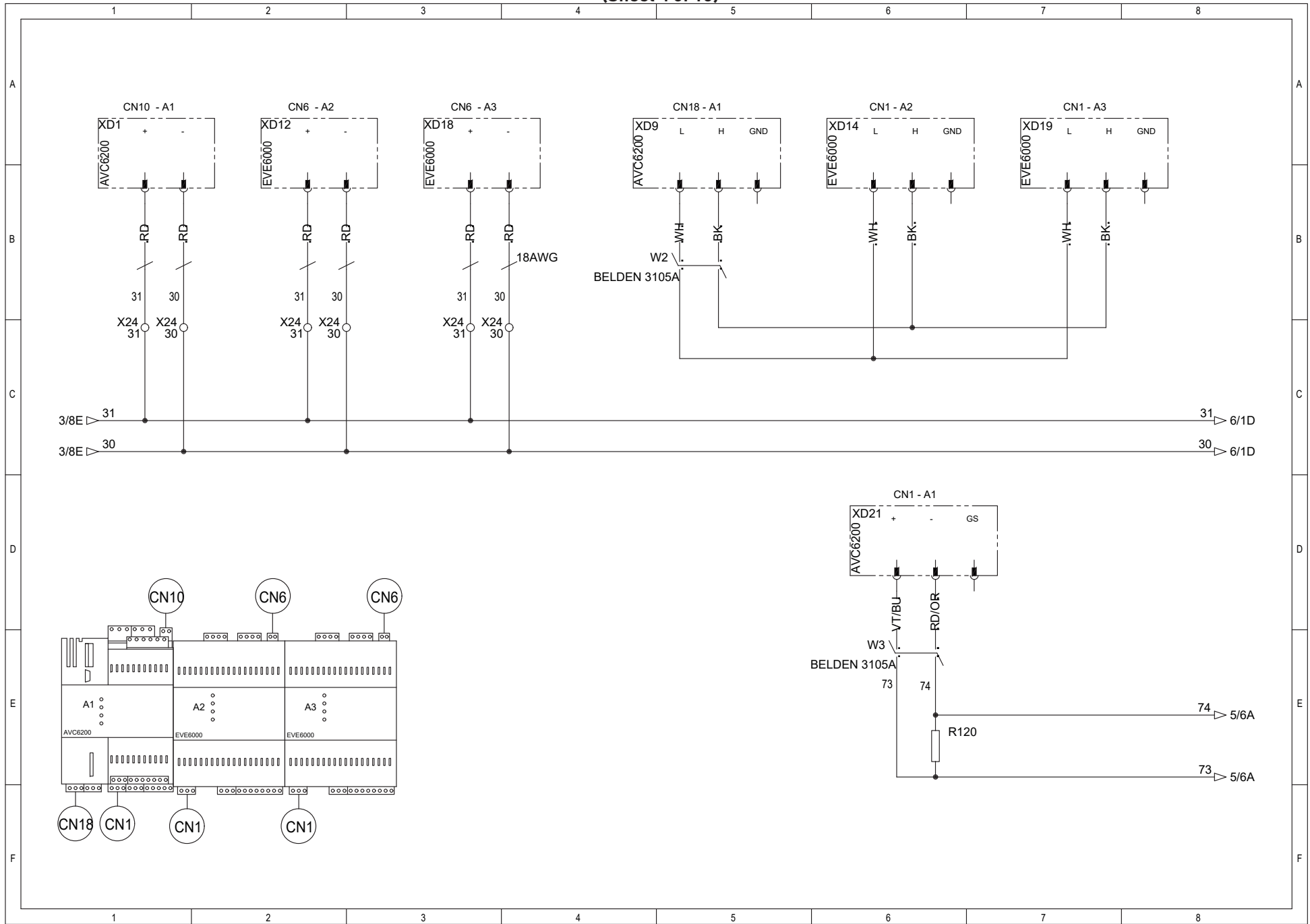



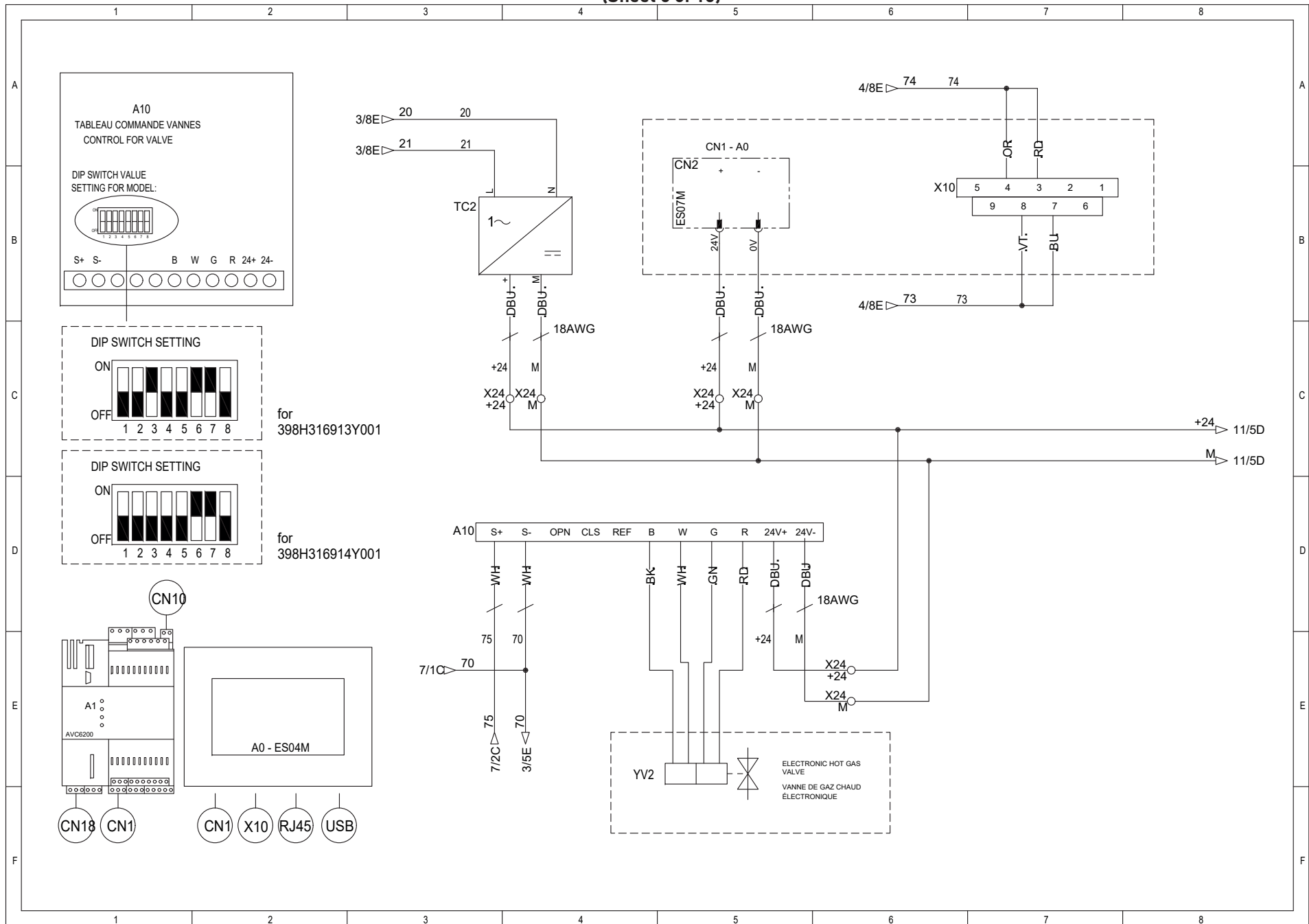

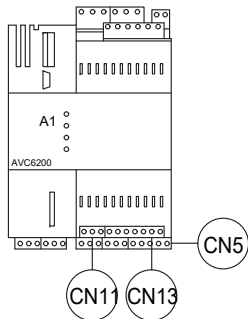
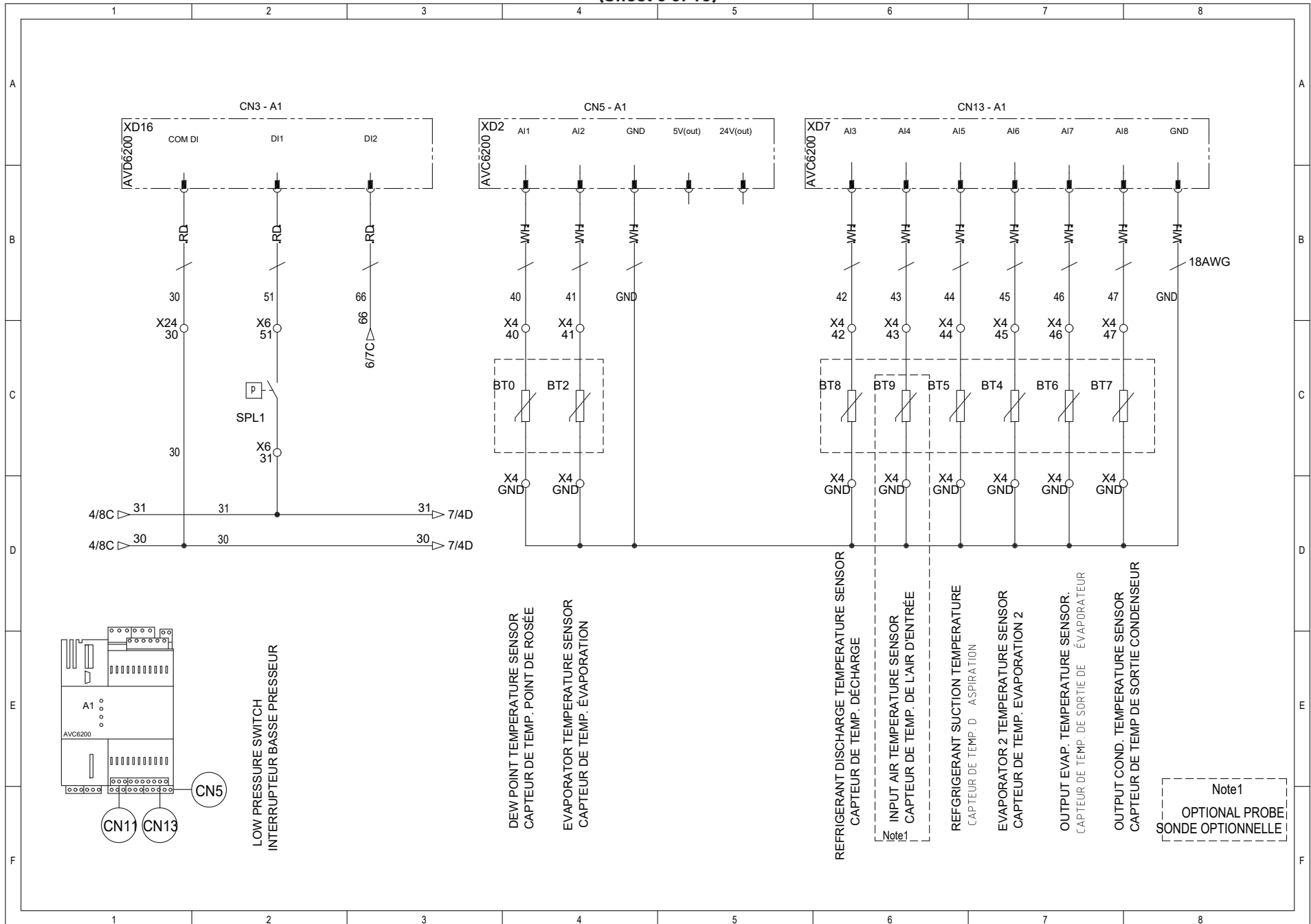

DEW POINT TEMPERATURE SENSOR  
CAPTEUR DE TEMP. POINT DE ROSEE

EVAPORATOR TEMPERATURE SENSOR  
CAPTEUR DE TEMP. EVAPORATION

REFRIGERANT DISCHARGE TEMPERATURE SENSOR  
CAPTEUR DE TEMP. DECHARGE

INPUT AIR TEMPERATURE SENSOR  
CAPTEUR DE TEMP. DE L'AIR D'ENTREE

REFRIGERANT SUCTION TEMPERATURE  
CAPTEUR DE TEMP. D'ASPIRATION

EVAPORATOR 2 TEMPERATURE SENSOR  
CAPTEUR DE TEMP. EVAPORATION 2

OUTPUT EVAP. TEMPERATURE SENSOR.  
CAPTEUR DE TEMP. DE SORTIE DE EVAPORATEUR

OUTPUT COND. TEMPERATURE SENSOR  
CAPTEUR DE TEMP. DE SORTIE CONDENSEUR

Note 1  
OPTIONAL PROBE  
SONDE OPTIONNELLE

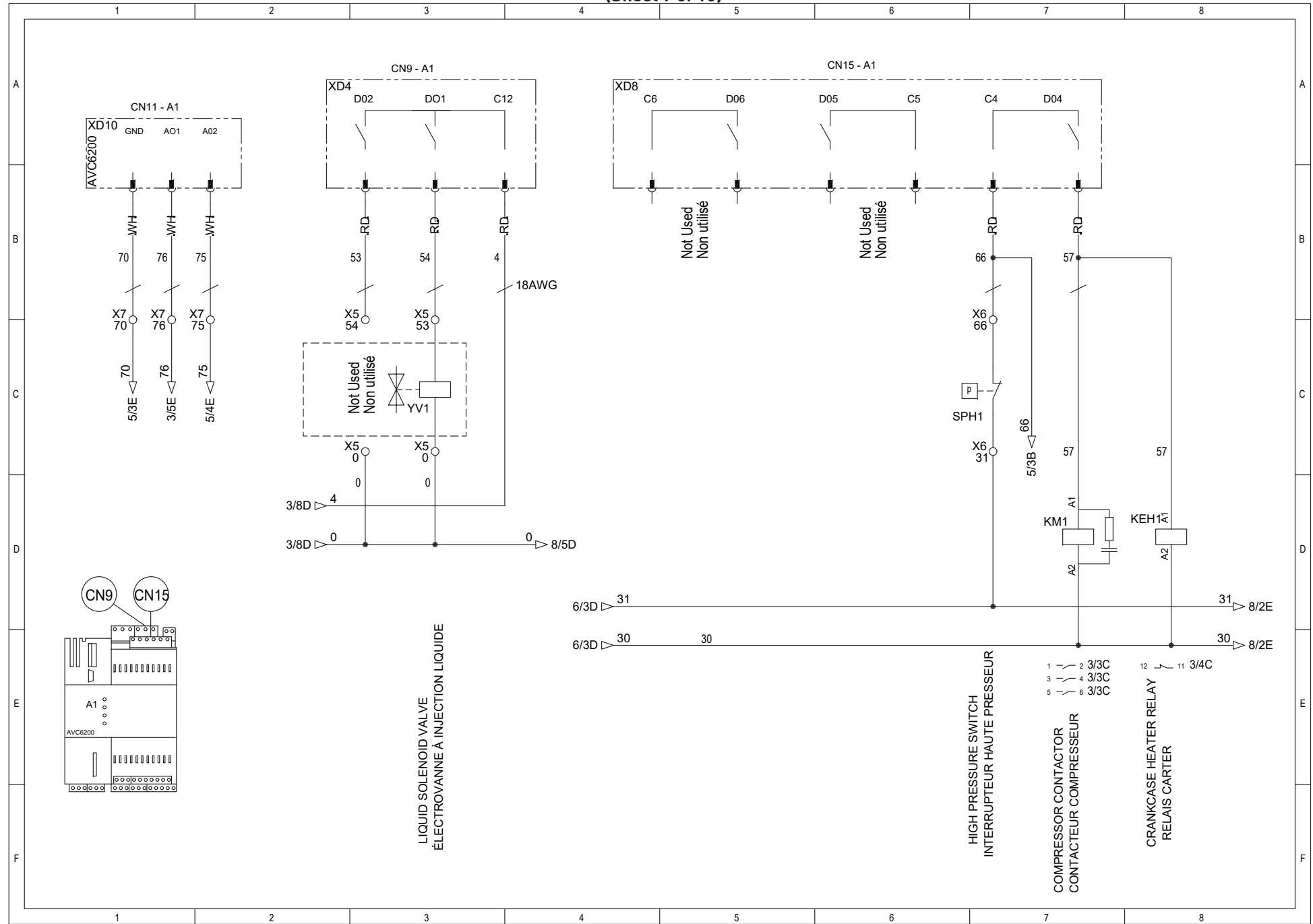

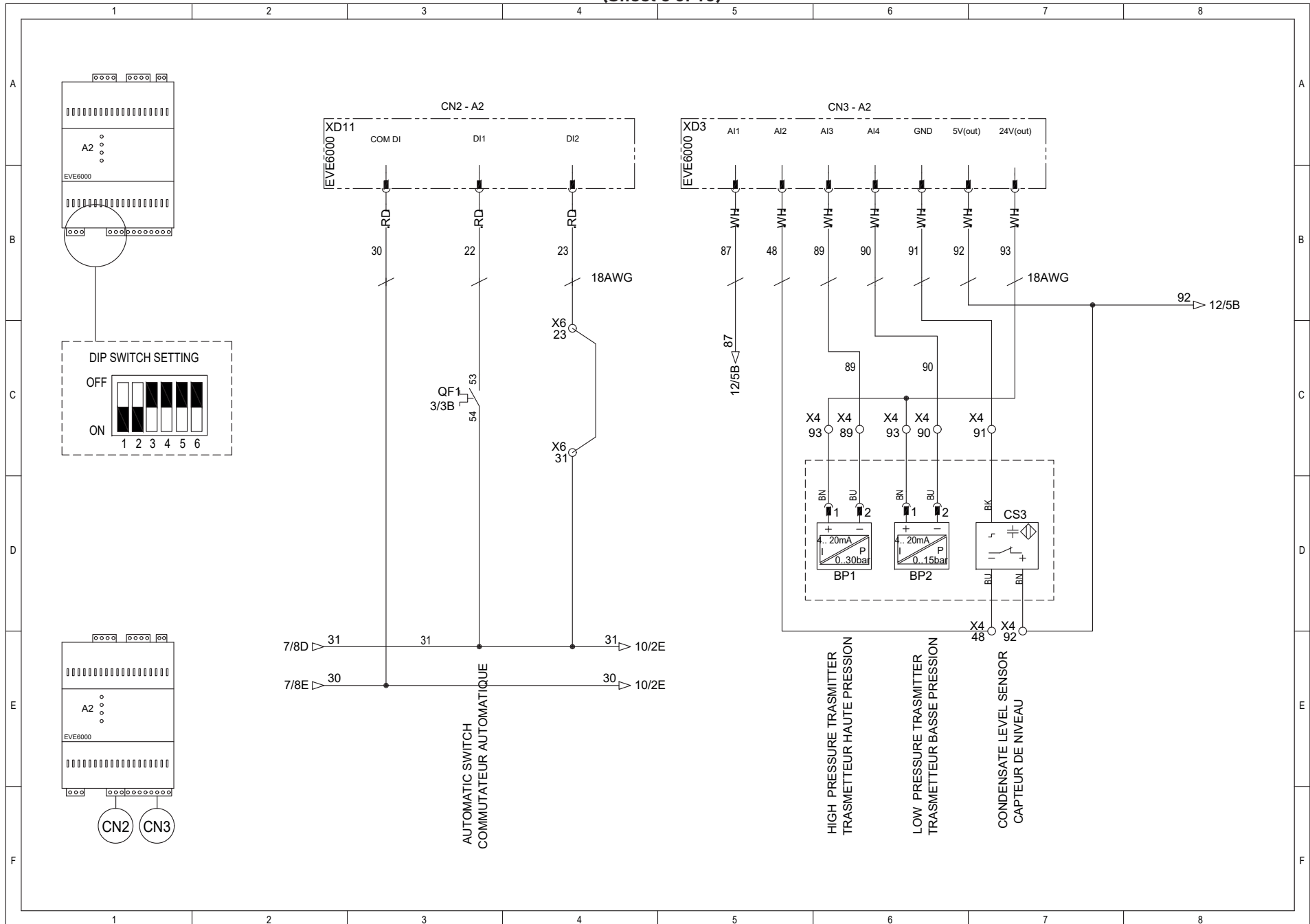

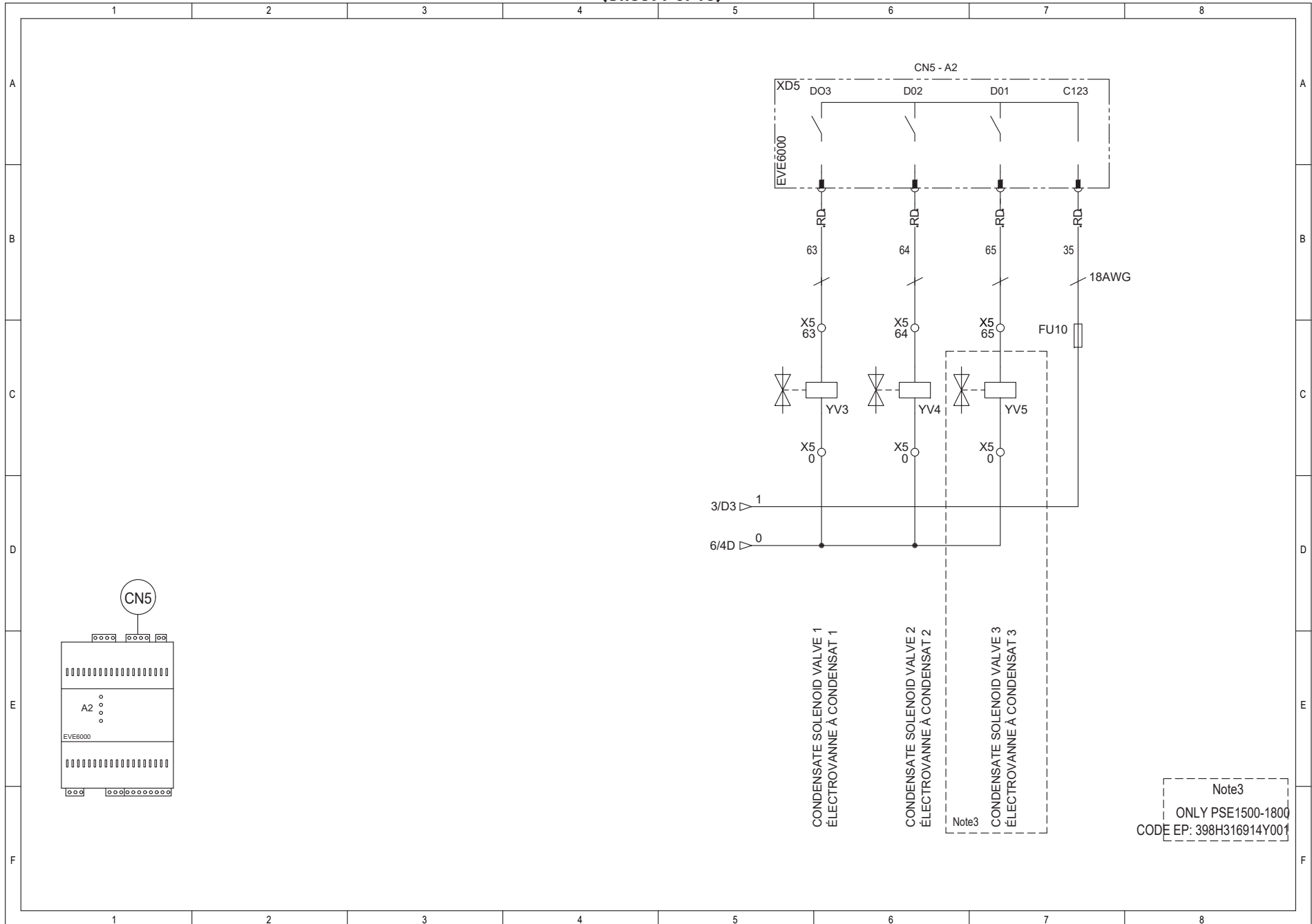

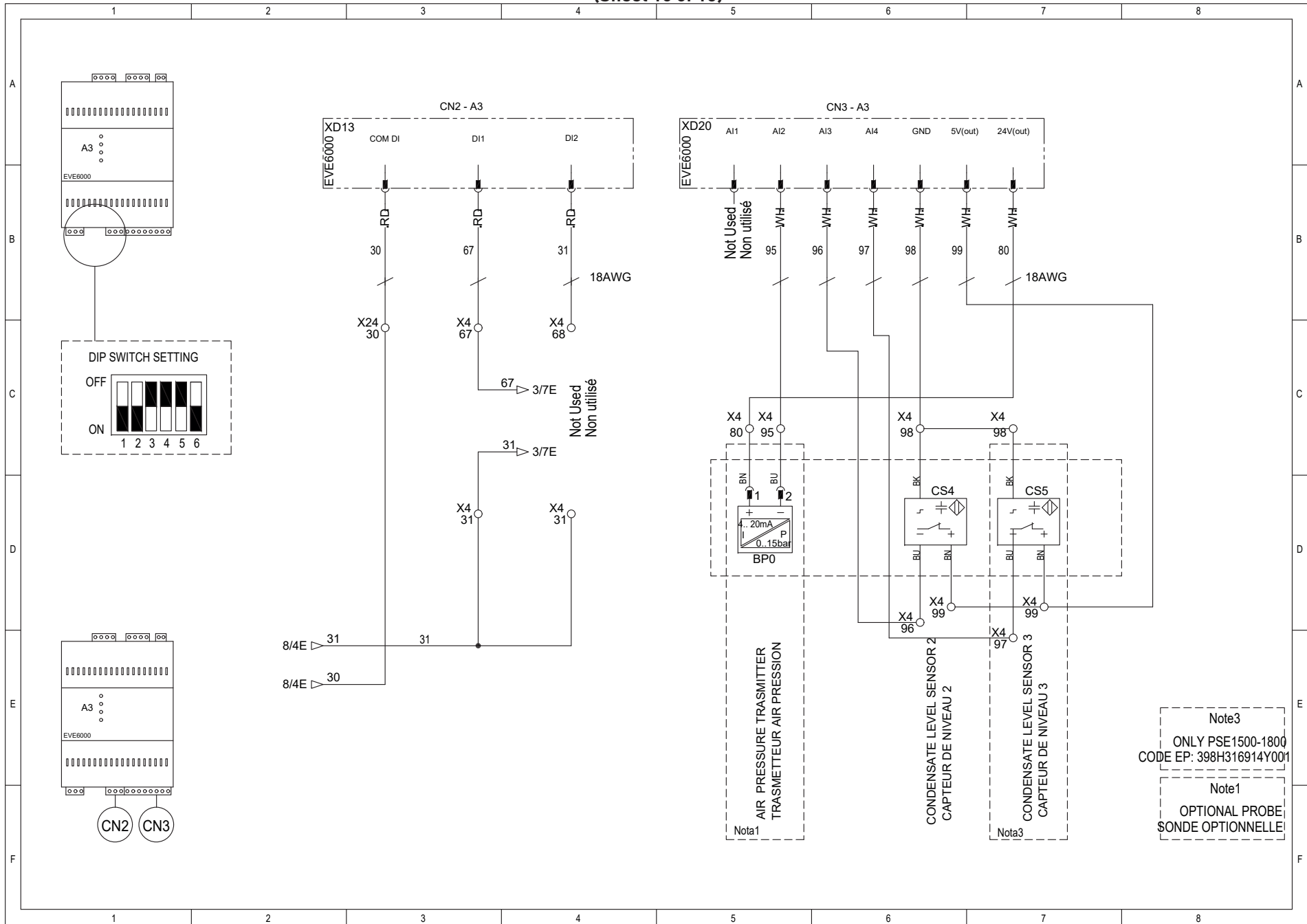

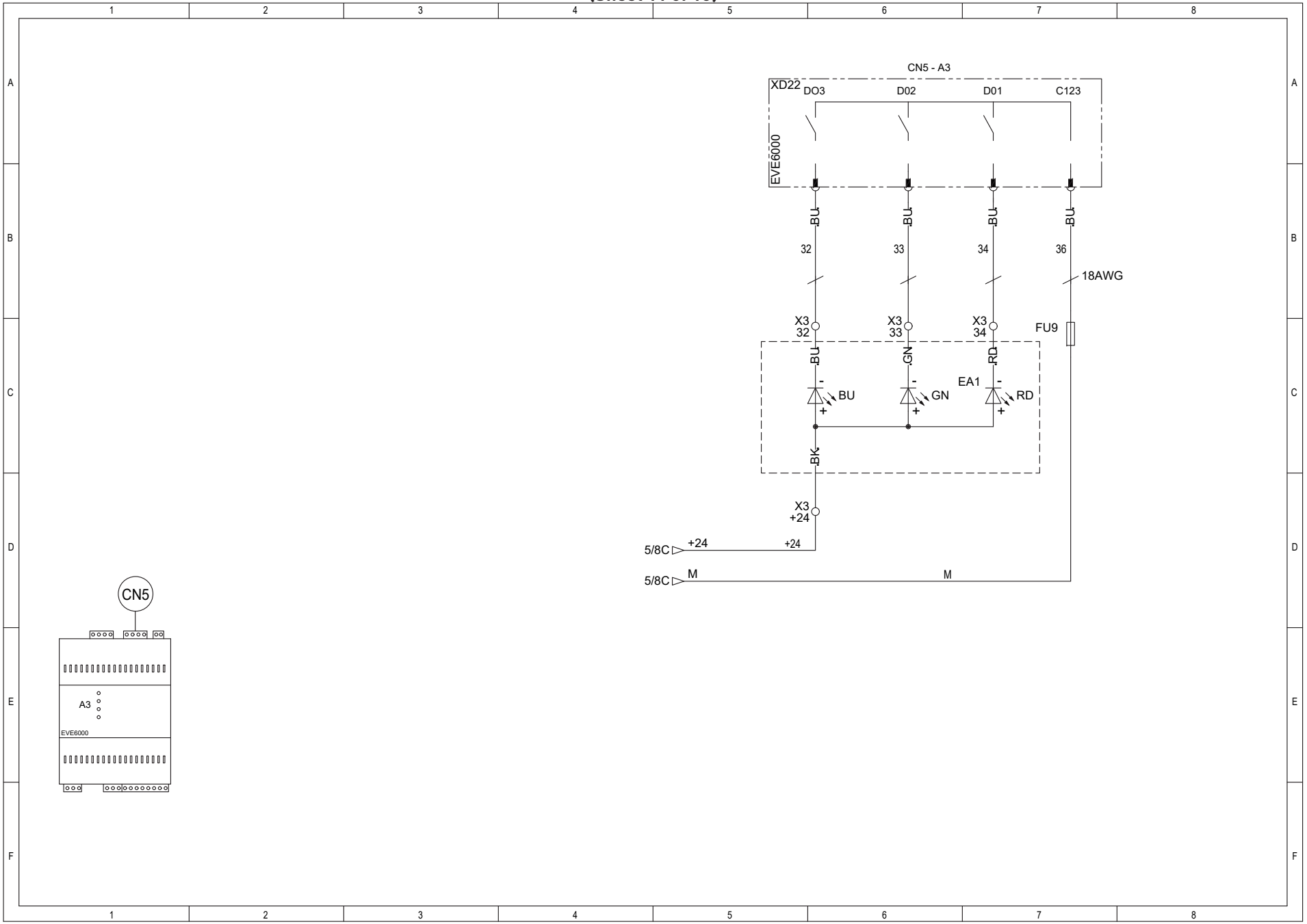

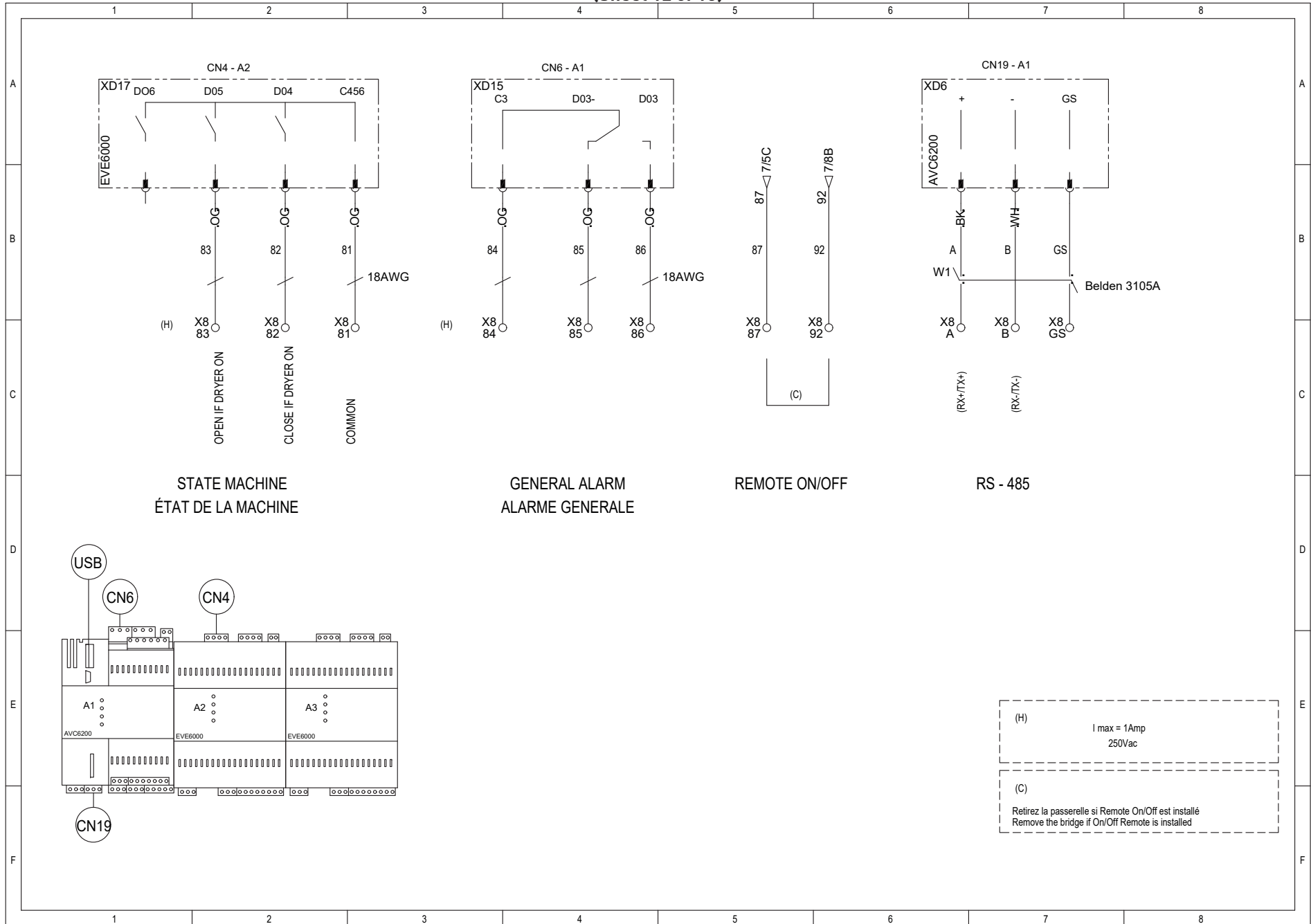







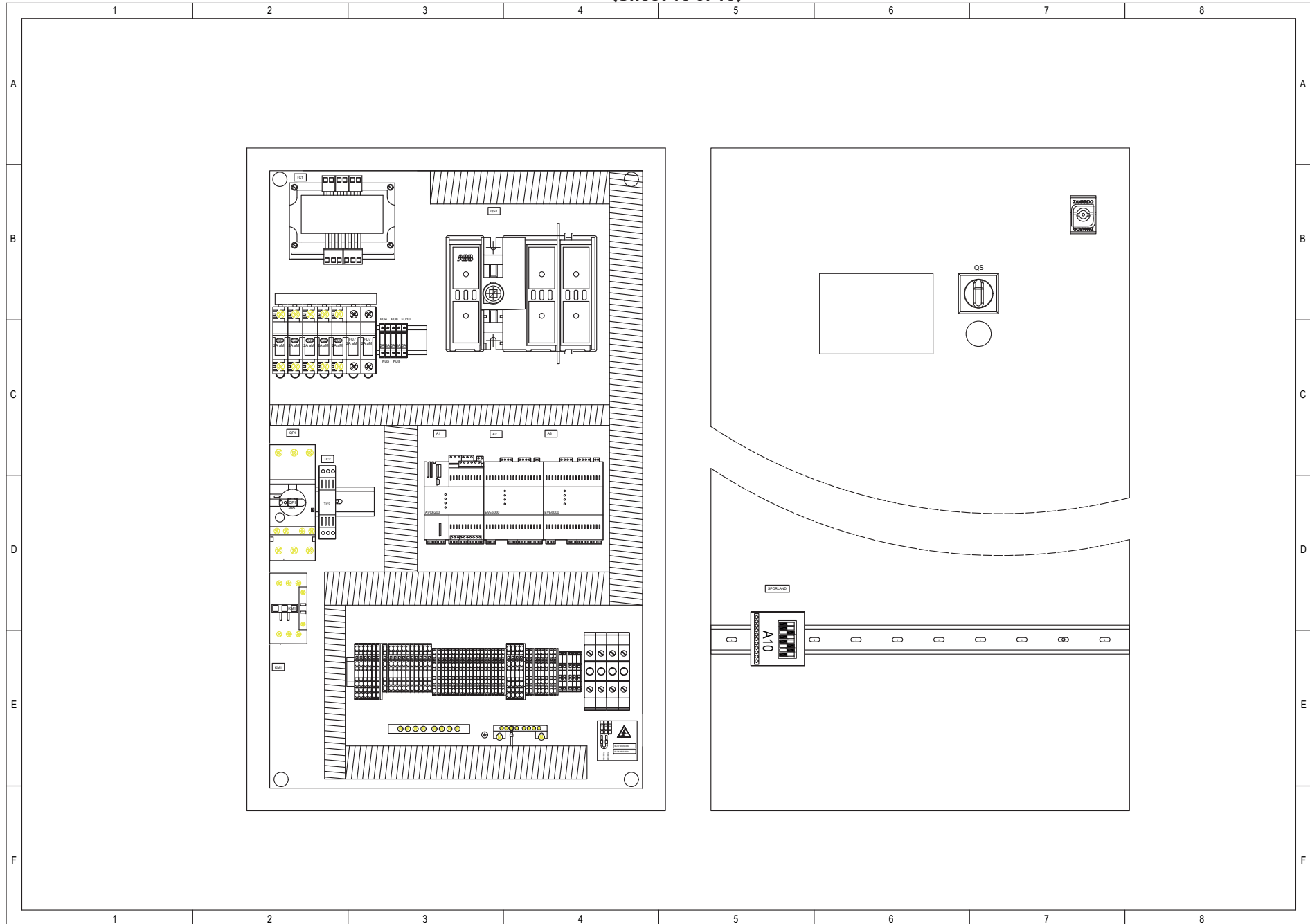







A division of Parker Hannifin Corporation

---

### **Parker Hannifin Corporation**

Industrial Gas Filtration and Generation Division

4087 Walden Avenue

Lancaster, NY 14086

Tel: + 1 800 343 4048

Web site: [www.parker.com/igfg](http://www.parker.com/igfg)

E-mail: [gsfsupport@parker.com](mailto:gsfsupport@parker.com)

### **Parker Hannifin Manufacturing S.r.l.**

Sede Legale: Via Sebastiano Caboto 1, Palazzina "A" 20094 Corsico (MI) Italy

Sede Operativa: **Gas Separation and Filtration Division EMEA** - Strada Zona Industriale,

435020 S. Angelo di Piove (PD) Italy

tel +39 049 971 2111- fax +39 049 9701911

Web-site: [www.parker.com](http://www.parker.com)